

# TOSHIBA



# DVD VIDEO PLAYER **SD-5970SU** **SD-5970SC**

## OWNER'S MANUAL



Introduction 2

Connections 18

Basic playback 26

Advanced playback 34

Function setup 51

Others 60



# SAFETY PRECAUTIONS

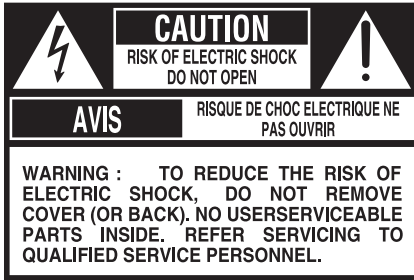

The lightning flash with arrowhead symbol, within an equilateral triangle, is intended to alert the user to the presence of uninsulated “dangerous voltage” within the product’s enclosure that may be of sufficient magnitude to constitute a risk of electric shock to persons.



The exclamation point within an equilateral triangle is intended to alert the user to the presence of important operating and maintenance (servicing) instructions in the literature accompanying the appliance.



The symbol for CLASS II (Double Insulation)

- WARNING:** TO REDUCE THE RISK OF FIRE OR ELECTRIC SHOCK, DO NOT EXPOSE THIS APPLIANCE TO RAIN OR MOISTURE. DANGEROUS HIGH VOLTAGES ARE PRESENT INSIDE THE ENCLOSURE. DO NOT OPEN THE CABINET. REFER SERVICING TO QUALIFIED PERSONNEL ONLY.
- CAUTION:** TO PREVENT ELECTRIC SHOCK, MATCH WIDE BLADE OF PLUG TO WIDE SLOT, FULLY INSERT.
- ATTENTION:** POUR EVITER LES CHOCES ELECTRIQUES, INTRODUIRE LA LAME LA PLUS LARGE DE LA FICHE DANS LA BORNE CORRESPONDANTE DE LA PRISE ET POUSSER JUSQU’AU FOND.
- CAUTION:** This Digital Video Disc Player employs a Laser System.  
To ensure proper use of this product, please read this owner’s manual carefully and retain for future reference. Should the unit require maintenance, contact an authorized service location - see service procedure.
- Use of controls or adjustments or performance of procedures other than those specified herein may result in hazardous radiation exposure.
- To prevent direct exposure to laser beam, do not try to open the enclosure.  
Visible and invisible laser radiation when open and interlocks defeated.  
DO NOT STARE INTO BEAM.
- FCC NOTICE:** This equipment has been tested and found to comply with the limits for a Class B digital device, pursuant to part 15 of the FCC Rule. These limits are designed to provide reasonable protection against harmful interference in a residential installation.  
This equipment generates, uses, and can radiate radio frequency energy and, if not installed and used in accordance with the instructions, may cause harmful interference to radio communications.  
However, there is no guarantee that interference will not occur in a particular installation.  
If this equipment does cause harmful interference to radio or television reception, which can be determined by turning the equipment off and on, the user is encouraged to try to correct the interference by one or more of the following measures:
- Reorient or relocate the receiving antenna.
  - Increase the separation between the equipment and receiver.
  - Connect the equipment into an outlet on a circuit different from that to which the receiver is connected.
  - Consult the dealer or an experienced radio/TV technician for help.

Changes or modifications made to this equipment, not expressly approved by Toshiba, or parties authorized by Toshiba, could void the user’s authority to operate the equipment.

The instructions shall state that an ALL-POLE MAINS SWITCH with a contact separation of at least 3 mm in each pole shall be incorporated in the electrical installation of the building.

**CAUTION:** These servicing instructions are for use by qualified service personnel only. To reduce the risk of electric shock do not perform any servicing other than that contained in the operating instructions unless you are qualified to do so.

In the spaces provided below, record the Model and Serial No. located on the rear panel of your DVD video player.

Model No. \_\_\_\_\_ Serial No. \_\_\_\_\_

Retain this information for future reference.

### Location of the required label

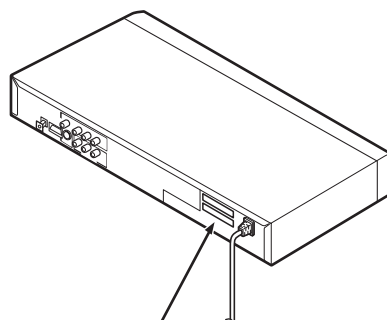

THIS PRODUCT COMPLIES WITH DHHS RULE 21 SUBCHAPTER J PARTS 1040-10 AND 1040-11 AT DATE OF MANUFACTURED.  
THIS DEVICE COMPLIES WITH PART 15 OF THE FCC RULES. OPERATION IS SUBJECT TO THE FOLLOWING TWO CONDITIONS: (1) THIS DEVICE MAY NOT CAUSE HARMFUL INTERFERENCE, AND (2) THIS DEVICE MUST ACCEPT ANY INTERFERENCE RECEIVED, INCLUDING INTERFERENCE THAT MAY CAUSE UNDESIRABLE OPERATION.

**TOSHIBA CORPORATION**  
1-1, SHIBAURA 1-CHOME, MINATO-KU,  
TOKYO 105-8001, JAPAN

MANUFACTURED
SERIAL NO.

Be aware that this equipment is still powered even after the ON/STANDBY indicator turns off (standby mode) by pressing the ON/STANDBY button. To disconnect this equipment completely from the mains power, pull out the power plug from the wall outlet.

# IMPORTANT SAFETY INSTRUCTIONS

---

**CAUTION: PLEASE READ AND OBSERVE ALL WARNINGS AND INSTRUCTIONS GIVEN IN THIS OWNER'S MANUAL AND THOSE MARKED ON THE UNIT. RETAIN THIS BOOKLET FOR FUTURE REFERENCE.**

This set has been designed and manufactured to assure personal safety. Improper use can result in electric shock or fire hazard. The safeguards incorporated in this unit will protect you if you observe the following procedures for installation, use and servicing. This unit is fully transistorized and does not contain any parts that can be repaired by the user.

**DO NOT REMOVE THE CABINET COVER, OR YOU MAY BE EXPOSED TO DANGEROUS VOLTAGE. REFER SERVICING TO QUALIFIED SERVICE PERSONNEL ONLY.**

1. Read these instructions.
2. Keep these instructions.
3. Heed all warnings.
4. Follow all instructions.
5. Do not use this apparatus near water.
6. Clean only with dry cloth.

7. Do not block any ventilation openings. Install in accordance with the manufacturer's instructions.
  
8. Do not install near any heat sources such as radiators, heat registers, stoves, or other apparatus (including amplifiers) that produce heat.
  
9. Do not defeat the safety purpose of the polarized or grounding-type plug. A polarized plug has two blades with one wider than the other. A grounding type plug has two blades and a third grounding prong. The wide blade or the third prong are provided for your safety. If the provided plug does not fit into your outlet, consult an electrician for replacement of the obsolete outlet.
  
10. Protect the power cord from being walked on or pinched particularly at plugs, convenience receptacles, and the point where they exit from the apparatus.
  
11. Only use attachments/accessories specified by the manufacturer.
  
12. Use only with the cart, stand, tripod, bracket, or table specified by the manufacturer, or sold with the apparatus. When a cart is used, use caution when moving the cart/apparatus combination to avoid injury from tip-over.



# IMPORTANT SAFETY INSTRUCTIONS

---

13. Unplug this apparatus during lightning storms or when unused for long periods of time.

14. Refer all servicing to qualified service personnel. Servicing is required when the apparatus has been damaged in any way, such as power-supply cord or plug is damaged, liquid has been spilled or objects have fallen into the apparatus, the apparatus has been exposed to rain or moisture, does not operate normally, or has been dropped.

## **ADDITIONAL SAFETY INSTRUCTIONS**

---

15. When you use headphones, keep the volume at a moderate level. If you use the headphones continuously with high volume sound, it may cause hearing damage.

16. Do not overload wall outlets; extension cords, or integral convenience receptacles as this can result in a risk of fire or electric shock.

17. Apparatus shall not be exposed to dripping or splashing and no objects filled with liquids, such as vases, shall be placed on the apparatus.

18. Keep your fingers well clear of the disc tray as it is closing. Neglecting to do so may cause serious personal injury.
  
19. Do not place a heavy object on or step on the apparatus. The object may fall, causing serious personal injury and serious damage to the apparatus.
  
20. Do not use a cracked, deformed, or repaired disc. These discs are easily broken and may cause serious personal injury and apparatus malfunction.
  
21. If the apparatus should smoke or smell, immediately disconnect the power cord from the wall outlet. Wait until the smoke or smell stops, then ask your dealer for a check and repair. Neglecting to do so may cause fire.
  
22. While it is thundering, do not touch the connecting cables or the apparatus.
  
23. The apparatus includes lead, an ingredient of solder used on the PCB, which is a harmful substance to human and the environment. When disposing of this apparatus, follow the rules and regulations in your area.

## Precautions

### Notes on handling

- When shipping the DVD video player, the original shipping carton and packing materials come in handy. For maximum protection, repack the unit as it was originally packed at the factory. Take care not to give it a shock or shake when carrying.
- Do not use volatile liquids, such as insect spray, near the DVD video player. Do not leave rubber or plastic products in contact with the DVD video player for a long time. They will leave marks on the finish.
- The top and rear panels of the DVD video player may become warm after a long period of use. This is not a malfunction.
- When the DVD video player is not in use, be sure to remove the disc and turn off the power.
- If you do not use the DVD video player for a long period, the unit may not function properly in the future. Turn on and use the DVD video player occasionally.

### Notes on locating

- Place the DVD video player on a level surface. Do not use it on a shaky or unstable surface such as a wobbling table or inclined stand. The loaded disc may come off the proper position and cause damage to the DVD video player.
- When you place this DVD video player near a TV, radio, or VCR, the playback picture may become poor and the sound may be distorted. In this case, place the DVD video player away from the TV, radio, or VCR.

### Notes on cleaning

Use a soft, dry cloth for cleaning.

- For stubborn dirt, soak the cloth in a weak detergent solution, wring well and wipe. Use a dry cloth to wipe it dry.  
Do not use any type of solvent, such as thinner and benzene, as they may damage the surface of the DVD video player.
- If you use a chemical saturated cloth to clean the unit, follow that product's instructions.

### To obtain a clear picture

The DVD video player is a high technology, precision device. If the optical pick-up lens and disc drive parts are dirty or worn down, the picture quality becomes poor. To obtain a clear picture, we recommend regular inspection and maintenance (cleaning or parts replacement) every 1,000 hours of use depending on the operating environment. For details, contact your nearest dealer.

### Notes on moisture condensation

#### Moisture condensation damages the DVD video player. Please read the following carefully.

Moisture condensation occurs, for example, when you pour a cold drink into a glass on a warm day. Drops of water form on the outside of the glass. In the same way, moisture may condense on the optical pick-up lens inside this unit, one of the most crucial internal parts of the DVD video player.

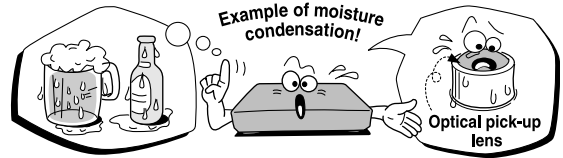

#### Moisture condensation occurs during the following cases.

- When you bring the DVD video player directly from a cold place to a warm place.
- When you use the DVD video player in a room where you just turned on the heater, or a place where the cold wind from the air conditioner directly hits the unit.
- In summer, when you use the DVD video player in a hot and humid place just after you move the unit from an air conditioned room.
- When you use the DVD video player in a humid place.

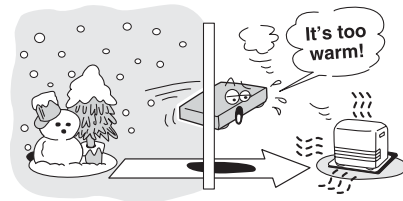

#### Do not use the DVD video player when moisture condensation may occur.

If you use the DVD video player in such a situation, it may damage discs and internal parts. Remove the disc, connect the power cord of the DVD video player to the wall outlet, turn on the DVD video player, and leave it for two or three hours. After two or three hours, the DVD video player will have warmed up and evaporated any moisture. Keep the DVD video player connected to the wall outlet and moisture condensation will seldom occur.

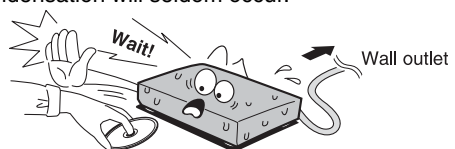



# Notes on Discs

## On handling discs

- Do not touch the playback side of the disc.

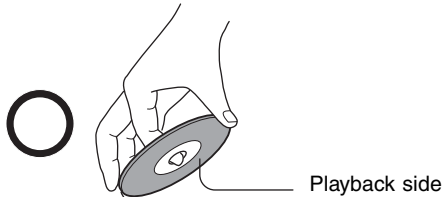

- Do not attach paper or tape to discs.



## On cleaning discs

- Fingerprints and dust on the disc cause picture and sound deterioration. Wipe the disc from the center outwards with a soft cloth. Always keep the disc clean.

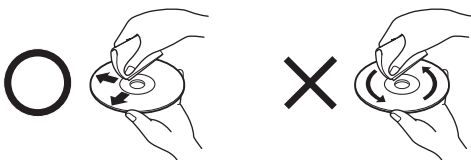

- If you cannot wipe off the dust with a soft cloth, wipe the disc lightly with a slightly moistened soft cloth and finish with a dry cloth.
- Do not use any type of solvent such as thinner, benzene, commercially available cleaners or antistatic spray for vinyl LPs. It may damage the disc.

## On storing discs

- Do not store discs in a place subject to direct sunlight or near heat sources.
- Do not store discs in places subject to moisture and dust such as a bathroom or near a humidifier.
- Store discs vertically in a case. Stacking or placing objects on discs outside of their case may cause warping.

## Structure of disc contents

Normally, DVD video discs are divided into titles, and the titles are sub-divided into chapters. VIDEO CDs and audio CDs are divided into tracks.

DVD video disc

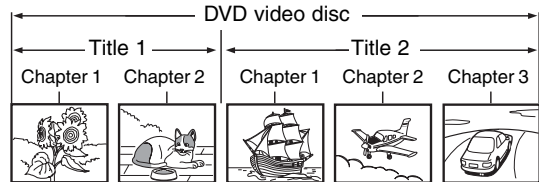

VIDEO CD/audio CD

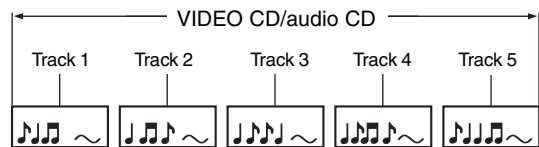

Each title, chapter or track is assigned a number, which is called "title number", "chapter number" or "track number" respectively.

There may be discs that do not have these numbers.

## Notes on copyright

It is forbidden by law to copy, broadcast, show, broadcast on cable, play in public, and rent copyrighted material without permission.

DVD video discs are copy protected, and any recordings made from these discs will be distorted.

This product incorporates copyright protection technology that is protected by method claims of certain U.S. patents and other intellectual property rights owned by Macrovision Corporation and other rights owners. Use of this copyright protection technology must be authorized by Macrovision Corporation, and is intended for home and other limited viewing uses only unless otherwise authorized by Macrovision Corporation. Reverse engineering or disassembly is prohibited.



## Notes on Discs (continued)

### About this owner's manual

This owner's manual explains the basic instructions of this DVD video player. Some DVD video discs are produced in a manner that allows specific or limited operation during playback. As such, the DVD video player may not respond to all operating commands. This is not a defect in the DVD video player. Refer to instruction notes of discs.

"⊘" may appear on the TV screen during operation. A "⊘" means that the operation is not permitted by the DVD video player or the disc.

### Notes on region numbers

The region number of this DVD video player is 1. If region numbers, which stand for their playable area, are printed on your DVD video disc and you do not find  or , disc playback will not be allowed by the player. (In this case, the DVD video player will display a message on-screen.) Some DVD discs may not have a region code label even though their playback is prohibited by area limits.

### On VIDEO CDs

This DVD video player supports VIDEO CDs equipped with the PBC (Version 2.0) function. (PBC is the abbreviation of Playback Control.) You can enjoy two playback variations depending on types of discs.

- **VIDEO CD not equipped with PBC function (Version 1.1)**



Sound and movie can be played on this DVD video player in the same way as an audio CD.

- **VIDEO CD equipped with PBC function (Version 2.0)**

In addition to operation of a VIDEO CD not equipped with the PBC function, you can enjoy playback of interactive software with search function by using the menu displayed on the TV screen (Menu Playback). Some of the functions described in this owner's manual may not work with some discs.

### Playable discs

This DVD video player can play the following discs.

	Disc Mark	Contents	Disc Size	Maximum playback time
DVD video discs		Audio + video (moving pictures)	12 cm	Approx. 4 hours (single sided disc)
				Approx. 8 hours (double sided disc)
			8 cm	Approx. 80 minutes (single sided disc)
				Approx. 160 minutes (double sided disc)
VIDEO CDs		Audio + video (moving pictures)	12 cm	Approx. 74 minutes
			8 cm	Approx. 20 minutes
Audio CDs		Audio	12 cm	Approx. 74 minutes
			8 cm (CD single)	Approx. 20 minutes
<p>The following discs are also available.</p> <ul style="list-style-type: none"> <li>● DVD-R discs of DVD video format</li> <li>● CD-R/CD-RW discs of CD-DA format</li> </ul> <p>Some of these discs may be incompatible.</p>				

- You cannot play discs other than those listed above.
- You cannot play DVD-RAM discs or non-standardized discs, etc., even if they may be labeled as above.
- This DVD video player uses the NTSC color system, and is not suitable to play DVD video discs recorded in any other color system (PAL, SECAM, etc.).

Because of problems and errors that can occur during the creation of DVD software and/or the manufacture of DVD discs, Toshiba America Consumer Products, L.L.C. and Toshiba of Canada, Ltd. cannot guarantee that this player will play every feature of every DVD bearing the DVD logo. As one of the creators of DVD technology, Toshiba DVD players are manufactured to the highest standards of quality and, as a result, such incompatibilities are very rare. If you happen to experience and difficulty playing a DVD on a Toshiba DVD player, please feel free to call our Contact listed in "How to Obtain Warranty Services" [65](#).

# Table of Contents

## Introduction

- **SAFETY PRECAUTIONS** ..... 2
- **IMPORTANT SAFETY INSTRUCTIONS** ... 4
- **Precautions** ..... 8
- **Notes on Discs** ..... 9
  - Notes on region numbers ..... 10
- **Table of Contents** ..... 11
- **Identification of Controls** ..... 12
  - Front panel ..... 12
  - Rear panel ..... 12
  - DVD display ..... 13
  - Remote control ..... 14
  - Loading batteries ..... 15
  - Operating with the remote control ..... 15

## Connections

- **Connecting to a TV** ..... 18
  - Connecting to a TV ..... 18
  - Connecting to an audio system and TV equipped with component video inputs ..... 19
  - Connecting to a display using HDMI ..... 20
- **Connecting to Optional Equipment** ..... 21
  - Connecting to an amplifier equipped with a Dolby Digital decoder ..... 22
  - Connecting to an amplifier equipped with Dolby Surround Pro Logic ..... 22
  - Connecting to an amplifier equipped with a DTS decoder ..... 23
  - Connecting to an amplifier equipped with an MPEG2 audio decoder ..... 23
  - Connecting to an amplifier equipped with a digital audio input ..... 24

## Basic playback

- **Playing a Disc** ..... 26
  - Basic playback ..... 26
- **Variable Speed Playback** ..... 28
  - Playing in fast reverse or fast forward directions ..... 28
  - Playing frame by frame ..... 28
  - Playing in slow-motion ..... 29
  - Resuming playback from the same location .. 29
- **Locating a Desired Section** ..... 30
  - Locating a title using the top menu ..... 30
  - Locating a desired section by entering the corresponding number ..... 31
  - Locating a specific chapter or track ..... 31

## Advanced playback

- **Accessing a Specific Location Directly** 34
  - Entering the time counter of the desired location ..... 34
- **Playing in Random Order** ..... 35
  - Playing titles, chapters or tracks in random order ..... 35
- **Playing Repeatedly** ..... 36
  - Repeating a title, chapter or tracks ..... 36
  - Repeating a specific segment ..... 36
- **Playing in a Favorite Order** ..... 37
  - Setting titles, chapters, or tracks in a favorite order ..... 37
- **Zooming a Picture** ..... 38
  - Zooming a picture ..... 38
- **Selecting the Camera Angle** ..... 39
  - Changing the camera angle ..... 39
- **Selecting Subtitles** ..... 40
  - Selecting a subtitle language ..... 40
- **Selecting a Language** ..... 41
  - Selecting a playback audio setting ..... 41
- **On-screen Display Operation** ..... 42
  - On-screen display operation ..... 42
- **Playing MP3/WMA Files** ..... 43
  - Playing MP3/WMA files ..... 43
- **Viewing JPEG Files** ..... 45
  - Viewing JPEG files ..... 45
  - Viewing a thumbnail view ..... 46

## Function setup

- **Customizing the Function Settings** ..... 50
  - Setting procedure ..... 50
  - Setting details ..... 52
- **Table of Languages** ..... 57

## Others

- **Operating a TV with the remote control** ..... 60
- **Before Calling Service Personnel** ..... 62
- **Specifications** ..... 63
- **Limited United States Warranty** ..... 64
  - How to Obtain Warranty Services ..... 65
- **CANADIAN WARRANTY INFORMATION** ..... 66

# Identification of Controls

See the page in    for details.

## Front panel

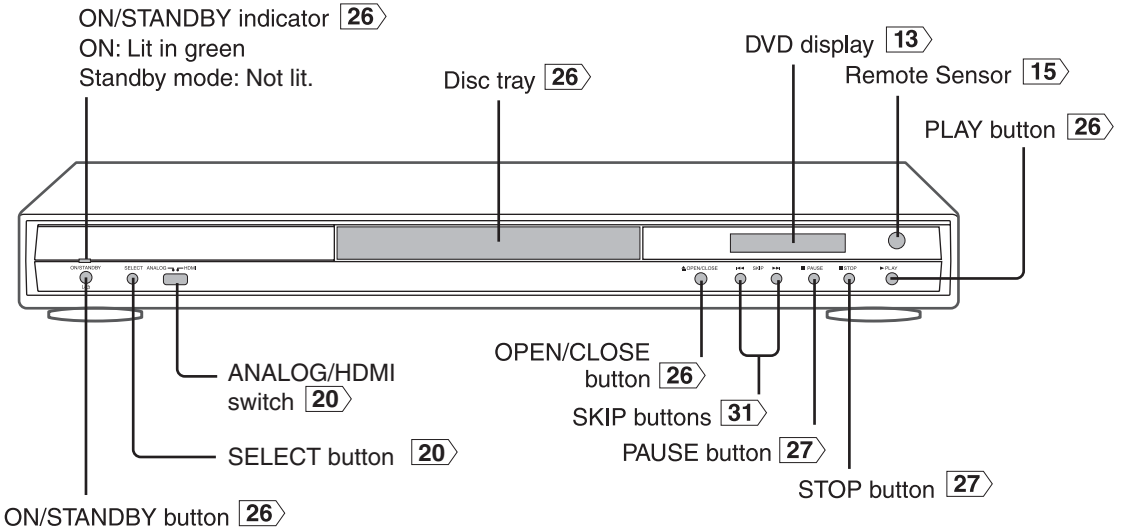

## Rear panel

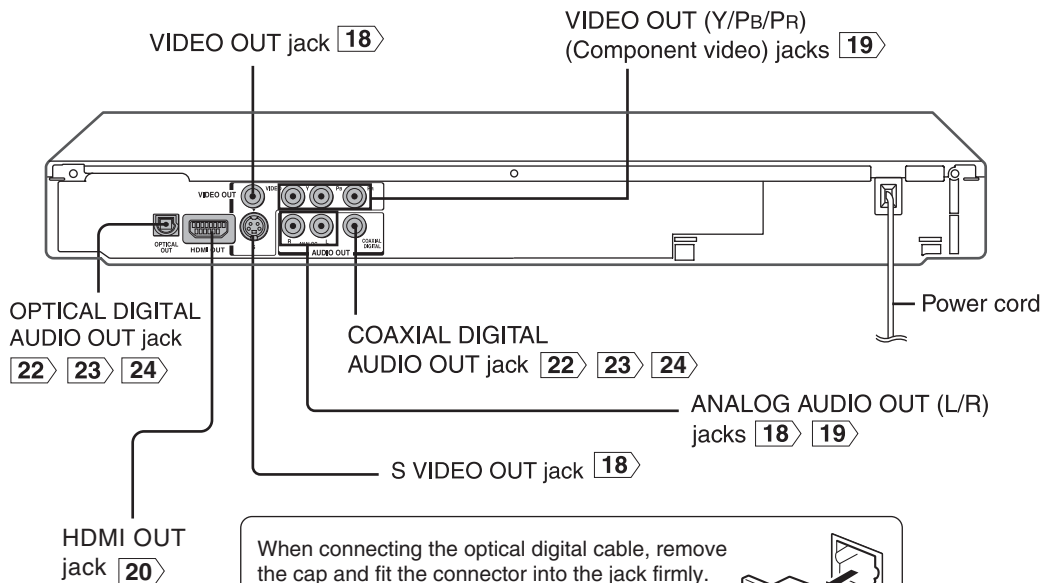

When connecting the optical digital cable, remove the cap and fit the connector into the jack firmly. When not using the jack, keep the cap inserted to protect it from dust intrusion.

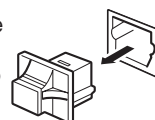

## DVD display

■ Pressing of the FL. DIM button on the remote control changes the brightness of the display.

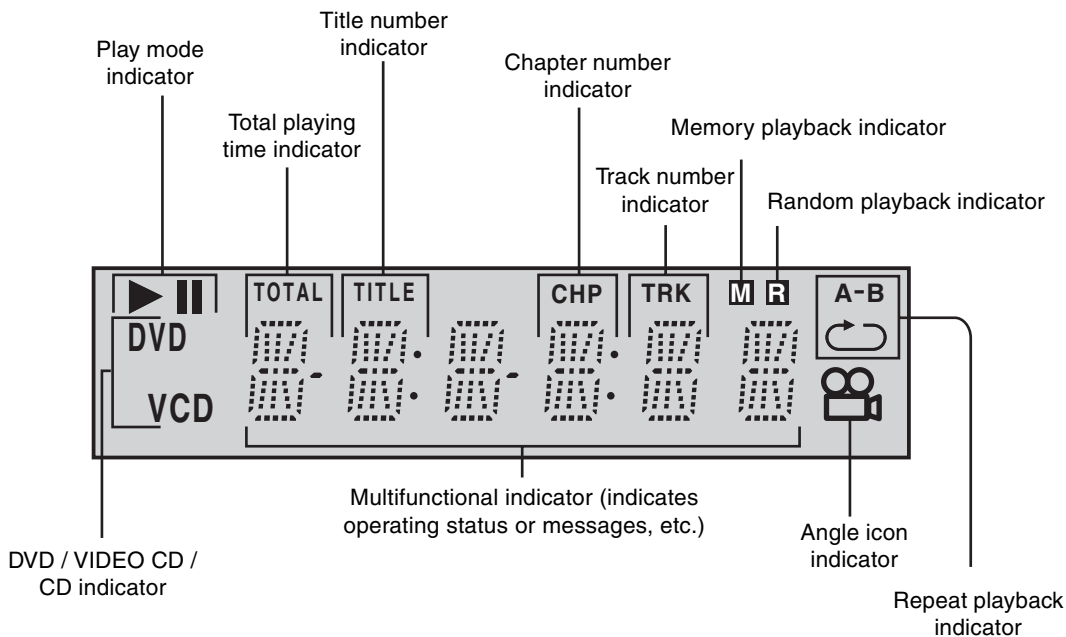

■ When you start playback, the elapsed time indicators appear. Pressing the FL. SELECT button switches them to the title/chapter/track number indicators. Some discs may not permit this operation.

The indicators vary depending on the kinds of discs you play.

DVD video disc	VIDEO CD	Audio CD
<ul style="list-style-type: none"> <li>During playback:</li> </ul> <p>Example</p> <p><b>Playing chapter 3 of title 2</b></p> <p>Some discs may not display chapter numbers or elapsed time.</p>	<ul style="list-style-type: none"> <li>During playback:</li> </ul> <p>Example</p> <p><b>Playing track 6</b></p> <p>Some discs may not display track numbers or elapsed time.</p>	<ul style="list-style-type: none"> <li>During playback:</li> </ul> <p>Example</p> <p><b>Playing track 6</b></p>

# Identification of Controls (continued)

The instructions in this manual describe the functions on the remote control. See the page in   for details.

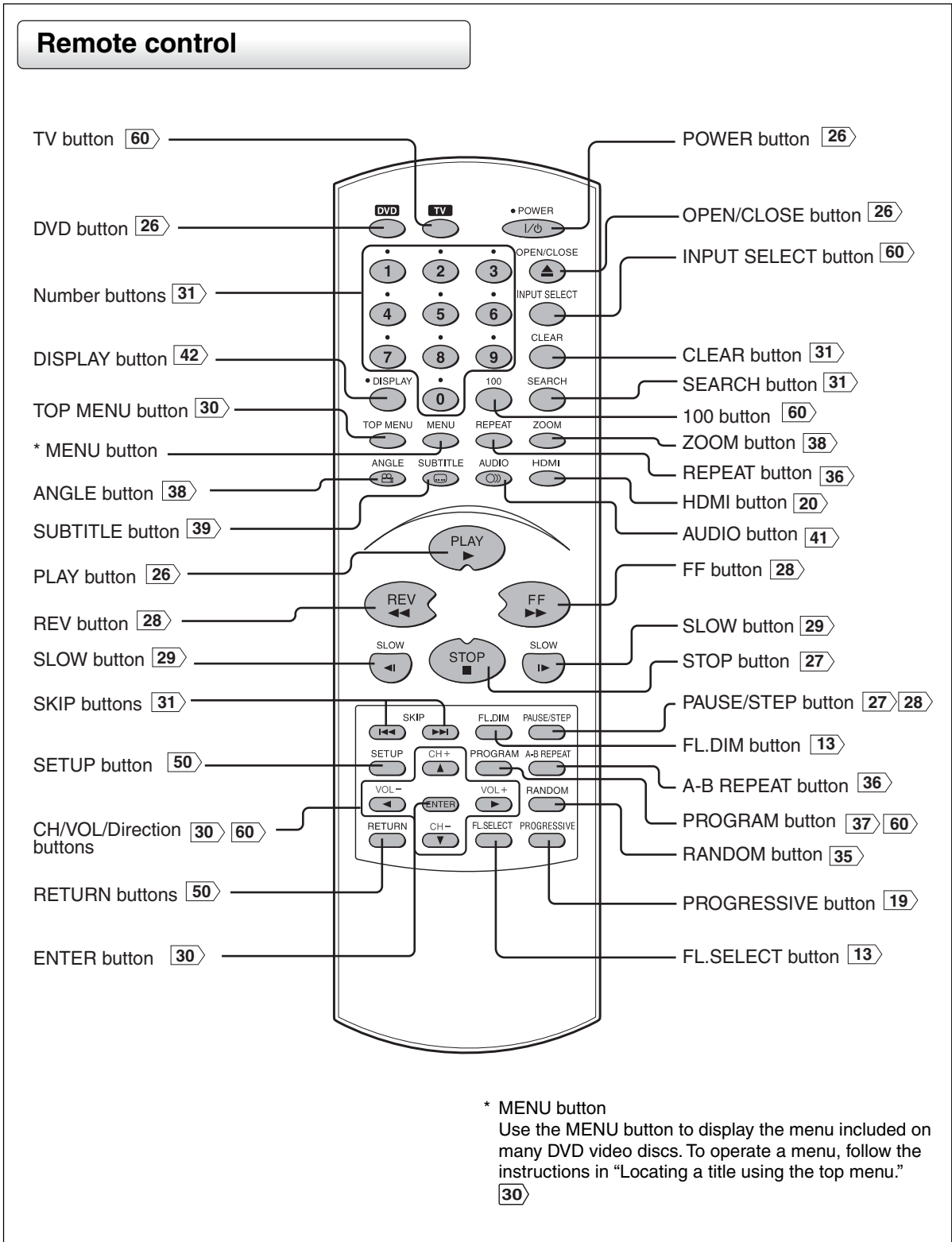

## Loading batteries

### 1 Open the cover.

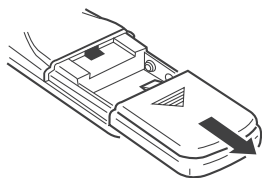

### 2 Insert batteries (AAA size).

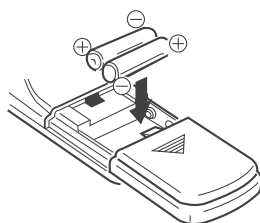

Make sure to match the + and – on the batteries to the marks inside the battery compartment.

### 3 Close the cover.

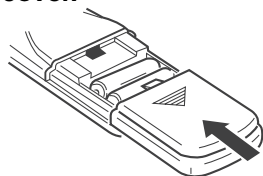

#### Notes on batteries

Improper use of batteries may cause battery leakage and corrosion. To operate the remote control correctly, follow the instructions below.

- Do not insert batteries into the remote control in the wrong direction.
- Do not charge, heat, open, or short-circuit the batteries. Do not throw batteries into a fire.
- Do not leave dead or exhausted batteries in the remote control.
- Do not use different types of batteries together, or mix old and new batteries.
- If you do not use the remote control for a long period of time, remove the batteries to avoid possible damage from battery corrosion.
- If the remote control does not function correctly or if the operating range becomes reduced, replace all batteries with new ones.
- If battery leakage occurs, wipe the battery liquid from the battery compartment, then insert new batteries.

## Operating with the remote control

### Point the remote control at the remote sensor and press the buttons.

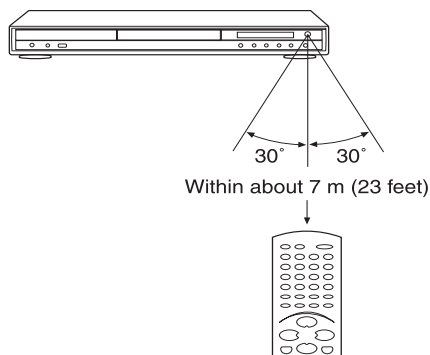

Distance: About 7 m (23 feet) from the front of the remote sensor  
 Angle: About 30° in each direction of the front of the remote sensor

\* Do not expose the remote sensor of the DVD video player to a strong light source such as direct sunlight or other illumination. If you do so, you may not be able to operate the DVD video player via the remote control.

#### Notes on the remote control

- Direct the remote control at the remote sensor of the DVD video player.
- When using the remote control, press the buttons at intervals of about 1 second to ensure the correct mode of operation.
- Do not drop or give the remote control a shock.
- Do not leave the remote control near an extremely hot or humid place.
- Do not spill water or put anything wet on the remote control.
- Do not open the remote control.

# Connections

Read this chapter first to make all necessary preparations.

- **Connecting to a TV**
- **Connecting to an audio system and TV equipped with component video inputs**
- **Connecting to a display using HDMI**
- **Connecting to an amplifier equipped with a Dolby Digital decoder**
- **Connecting to an amplifier equipped with Dolby Surround Pro Logic**
- **Connecting to an amplifier equipped with a DTS decoder**
- **Connecting to an amplifier equipped with an MPEG2 audio decoder**
- **Connecting to an amplifier equipped with a digital audio input**



# Connecting to a TV

Connect the DVD video player to your TV.

For details of output sound, see [41](#).

## Connecting to a TV

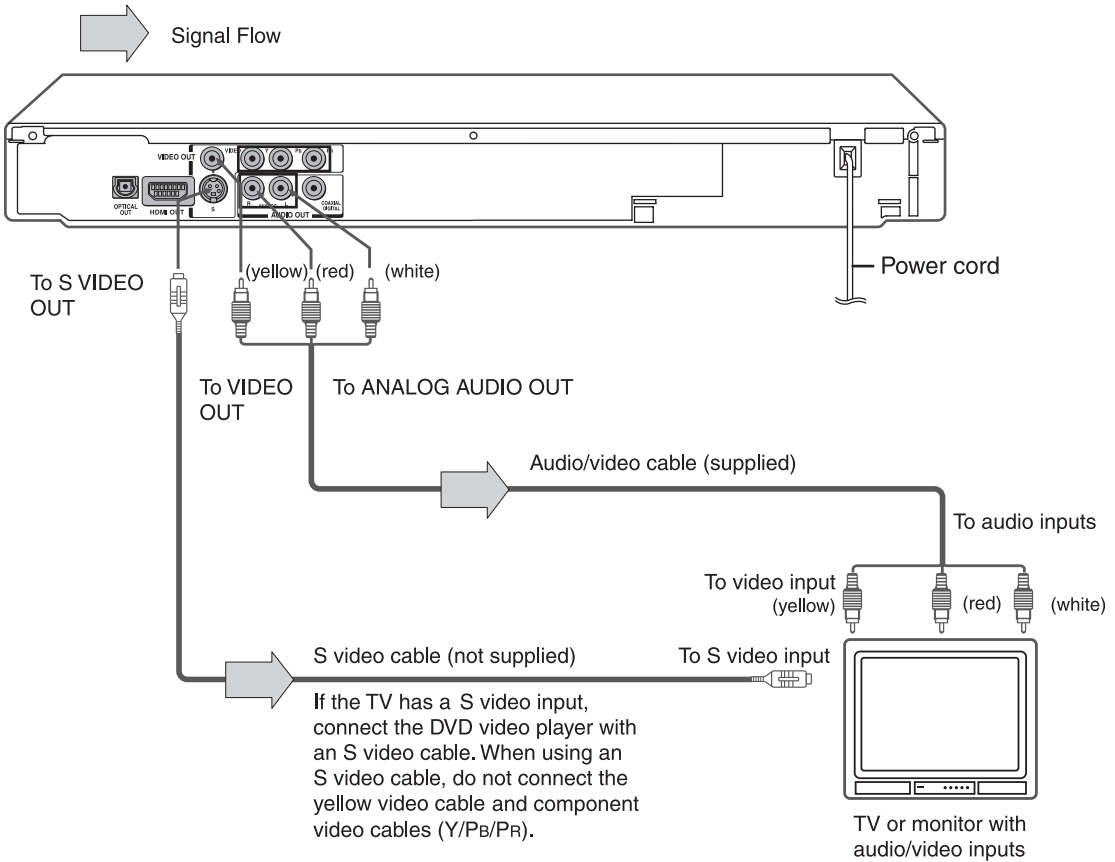

### ANALOG/HDMI SETTING

In standby mode, select ANALOG mode through the ANALOG/HDMI switch on the front panel.

• Make the following setting.

On-screen display	Select:	Page
"Digital Out"	"PCM" or "Raw"	<a href="#">50</a> <a href="#">55</a>
"Video Output"	CVBS * YUV	<a href="#">50</a> <a href="#">54</a>

\* Only for analog video out jack (yellow) connection with progressive scan off.

### Notes

- Refer to the owner's manual of the connected TV as well.
- When you connect the DVD video player to your TV, be sure to turn off the power and unplug both units from the wall outlet before making any connections.
- If your television set has one audio input, connect the left and right audio outputs of the DVD video player to a Y cable adapter (not supplied) and then connect to your TV.
- Connect the DVD video player directly to your TV. If you connect the DVD video player to a VCR, TV/VCR combination or video selector, the playback picture may be distorted as DVD video discs are copy protected.
- Analog audio out will not have sound if DTS playback is selected.
- Do not set the ANALOG/HDMI selection other than standby mode.

### Interlaced outputs (ColorStream®)

Some TVs or monitors are equipped with component video inputs. Connecting to these inputs allows you to enjoy higher quality picture playback.

Actual labels for component video inputs may vary depending on the TV manufacturer. (ex. Y, R-Y, B-Y or Y, C<sub>B</sub>, C<sub>R</sub>)

In some TVs or monitors, the color levels of the playback picture may be reduced slightly or the tint may change. In such a case, adjust the TV or monitor for optimum performance.

### Progressive outputs (ColorStream®Pro)

Some TVs or monitors are equipped with component video inputs that are capable of reproducing a progressively scanned video signal. Connecting to these inputs allows you to view the highest quality pictures with less flicker.

Consumers should note that not all high definition television sets are fully compatible with this product and may cause artifacts to be displayed in the picture. In case of 525 progressive scan picture problems, it is recommended that the user switch the connection to the "standard definition" output. If there are questions regarding our TV set compatibility with this model 525p DVD player, please contact our Customer Service Center.

## Connecting to a TV (Using the component video jacks)

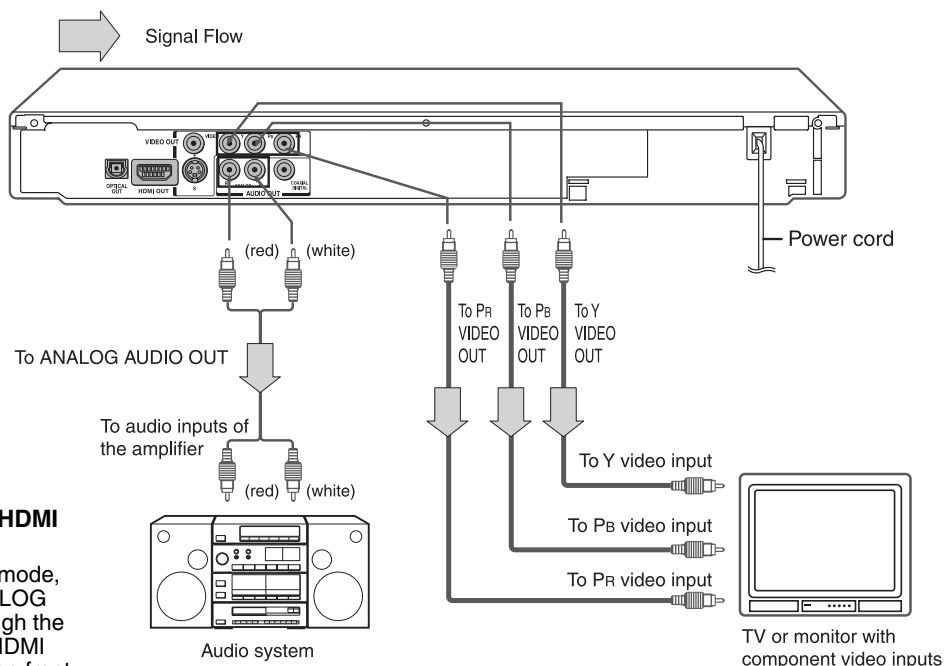

### ■ ANALOG/HDMI SETTING

In standby mode, select ANALOG mode through the ANALOG/HDMI switch on the front panel.

### ■ Switching the output signal (interlaced/progressive) using the remote control

You can temporarily switch the output signal for better picture quality. Press **PROGRESSIVE** on the remote control during stop mode. Press **PROGRESSIVE** again to turn off progressive mode.

- Make the following setting.

On-screen display	Select:	Page
"Digital Out"	"PCM" or "Raw"	[50] [55]
"Video Output"	YUV	[50] [54]

### Notes

- Refer to the owner's manual of the connected equipment as well.
- When you connect the DVD video player to other equipment, be sure to turn off the power and unplug all of the equipment from the wall outlet before making any connections.
- If you place the DVD video player near a tuner or radio, the radio broadcast sound might be distorted. In this case, place the DVD video player away from the tuner and radio.
- The output sound of the DVD video player has a wide dynamic range. Be sure to adjust the receiver's volume to a moderate listening level. Otherwise, high volume sound may damage your hearing as well as the speakers.
- Turn off the amplifier before you connect or disconnect the DVD video player's power cord. If you leave the amplifier power on, the speakers may be damaged.
- Progressive can be on/off only when video output is set to YUV. [54]
- In component connections (YUV), the screen might become pinkish in color when the video output is set to CVBS. This is not a malfunction of this unit. [54]
- When Progressive is on, only component video will be output.
- Analog audio out will not have sound if DTS playback is selected.
- When using component video cables, do not connect the S video cable.

# Connecting to a TV (Continued)

## About HDMI

HDMI (High Definition Multimedia Interface) supports both video and audio on a single digital connection for use with DVD players, DTV, set-top boxes, and other AV devices. HDMI was developed to provide the technologies of High Bandwidth Digital Content Protection (HDCP) as well as Digital Visual Interface (DVI) in one specification. HDCP is used to protect digital content transmitted and received by DVI-compliant or HDMI-compliant displays.

HDMI has the capability to support standard, enhanced, or high-definition video plus standard to multi-channel surround-sound audio. HDMI features include uncompressed digital video, a bandwidth of up to 2.2 gigabytes per second (with HDTV signals), one connector (instead of several cables and connectors), and communication between the AV source and AV devices such as DTVs.

*HDMI, the HDMI logo and High-Definition Multimedia Interface are trademarks or registered trademarks of HDMI licensing LLC.*

## Connecting to a display (Using the HDMI cable)

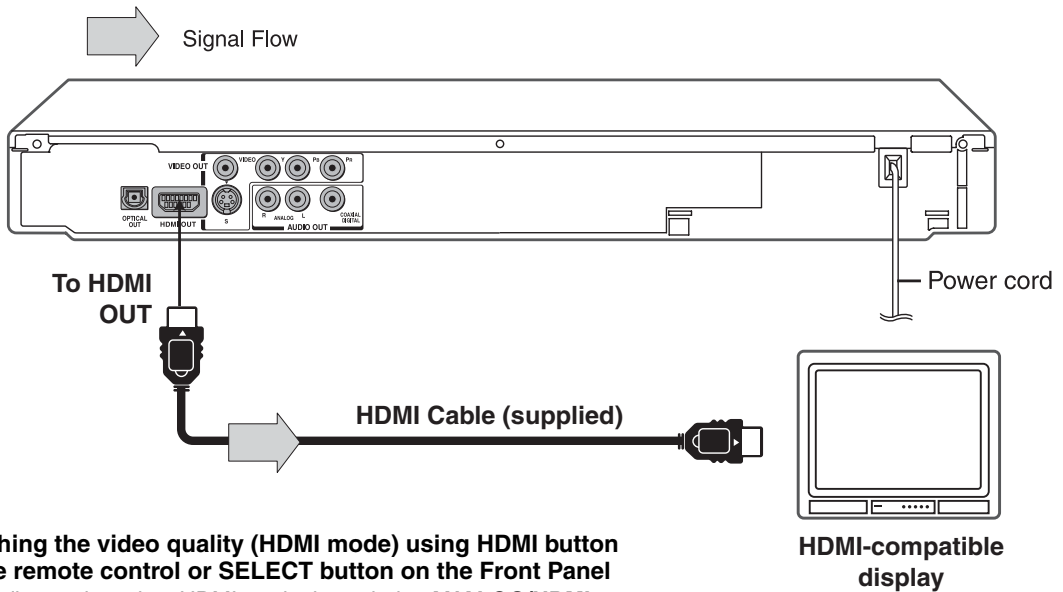

### Switching the video quality (HDMI mode) using HDMI button on the remote control or SELECT button on the Front Panel

In standby mode, select HDMI mode through the **ANALOG/HDMI** switch on the front panel. Press **HDMI** button on the remote control or **SELECT** button on the front panel to receive suitable video quality. The video quality is required to match your TV having HDMI feature and suitable quality, please check your TV owner's manual. Pressing the **HDMI** button or **SELECT** button changes the video quality as follows:

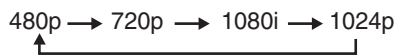

both TV and DVD display **[13]** will show your selected video quality within 2 seconds.

### Notes

- Refer to the owner's manual of the connected TV as well.
- When you connect the DVD video player to your TV, be sure to turn off the power and unplug both units from the wall outlet before making any connections.
- Select HDMI mode through the ANALOG/HDMI switch of front panel, analog video out jack (Yellow) will not have video signal.
- If you have a HDMI (with HDCP) equipped monitor or display, you can connect it to this player using the supplied HDMI cable.
- The HDMI connector outputs uncompressed digital video, as well as almost every kind of digital audio that the player is compatible with, including DVD-Video, Video CD, CD and MP3.
- When using HDMI cable, do not connect to other analog video outputs.
- No sound will be output from the HDMI cable if the Digital Out is not set to PCM. **[55]**

• Make the following setting.

On-screen display	Select:	Page
"Digital Out"	"PCM"	<b>[50]</b> <b>[55]</b>

# Connecting to Optional Equipment

You can enjoy high quality dynamic sounds by connecting the DVD video player to optional audio equipment.

- For connection to your TV, see “Connecting to a TV” [18](#) [19](#) [20](#).
- For details of output sound, see [41](#).
- This section uses the following reference marks.

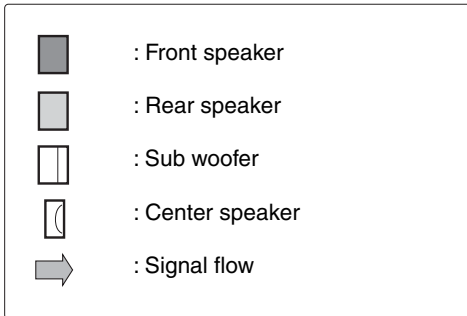

## Notes

- DO NOT connect the OPTICAL or COAXIAL DIGITAL AUDIO OUT jack of the DVD video player to the AC-3 RF input of a Dolby Digital Receiver. This input on your A/V Receiver is reserved for Laserdisc use only and is incompatible with the OPTICAL / COAXIAL DIGITAL AUDIO OUT jack of the DVD video player.
- Connect the COAXIAL DIGITAL AUDIO OUT jack of the DVD video player to the “DIGITAL (COAXIAL)” input of a Receiver or Processor.
- Connect the OPTICAL DIGITAL AUDIO OUT jack of the DVD video player to the “DIGITAL (OPTICAL)” input of a Receiver or Processor.
- Refer to the owner’s manual of the connected equipment as well.
- When you connect the DVD video player to other equipment, be sure to turn off the power and unplug all of the equipment from the wall outlet before making any connections.
- The output sound of the DVD video player has a wide dynamic range. Be sure to adjust the receiver’s volume to a moderate listening level. Otherwise, the speakers may be damaged by a sudden high volume sound.
- Turn off the amplifier before you connect or disconnect the DVD video player’s power cord. If you leave the amplifier power on, the speakers may be damaged.

## Warning

- When you are connecting (via the OPTICAL or COAXIAL DIGITAL AUDIO OUT jack) an AV decoder that does not have Dolby Digital, Digital Theater Systems (DTS) or MPEG2 decoding function, be sure to set “Digital Out” to “PCM” from the on-screen displays [50](#) [55](#). Otherwise, high volume sound may damage your hearing as well as the speakers.
- When playing DTS-encoded discs (audio CDs), excessive noise may be output from the analog audio output jacks. To avoid possible damage to the audio system, you should take proper precautions when the analog audio output jacks of the DVD video player are connected to an amplification system. To enjoy DTS Digital Surround™ playback, an external 5.1 channel DTS Digital Surround™ decoder system must be connected to the OPTICAL or COAXIAL DIGITAL AUDIO OUT jack of the DVD video player.

# Connecting to Optional Equipment (Continued)

## Connecting to an amplifier equipped with a Dolby Digital decoder

### Dolby Digital

Dolby Digital is the surround sound technology used in theaters showing the latest movies, and is now available to reproduce this realistic effect in the home. You can enjoy motion picture and live concert DVD video discs with this dynamic realistic sound by connecting the DVD video player to a 6 channel amplifier equipped with a Dolby Digital decoder or Dolby Digital processor. If you have a Dolby Surround Pro Logic decoder, you will obtain the full benefit of Pro Logic from the same DVD movies that provide full 5.1-channel Dolby Digital soundtracks, as well as from titles with the Dolby Surround mark.

Manufactured under license from Dolby Laboratories. "Dolby", "Pro Logic" and the double-D symbol are trademarks of Dolby Laboratories. Confidential unpublished works. Copyright 1992-1997 Dolby Laboratories. All rights reserved.

- Use DVD video discs encoded via the Dolby Digital recording system.
- Make the following setting.

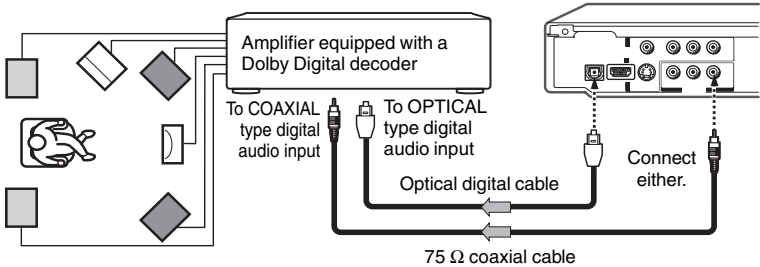

On-screen display	Select:	Page
"Digital Out"	"Raw" or "PCM"	50
		55
Recording system	D D	41

## Connecting to an amplifier equipped with Dolby Surround Pro Logic

### Dolby Surround Pro Logic

You can enjoy the dynamic realistic sound of Dolby Surround Pro Logic by connecting an amplifier and speaker system (right and left front speakers, a center speaker, and one or two rear speakers).

- With an amplifier equipped with Dolby Digital  
Connect the equipment the same way as described in "Connecting to an amplifier equipped with a Dolby Digital decoder." Refer to that amplifier's owner's manual and set the amplifier so you can enjoy Dolby Surround Pro Logic sound.
- With an amplifier not equipped with Dolby Digital  
Connect the equipment as follows.

- Make the following setting.

On-screen display	Select:	Page
"Digital Out"	"Raw" or "PCM"	50
		55

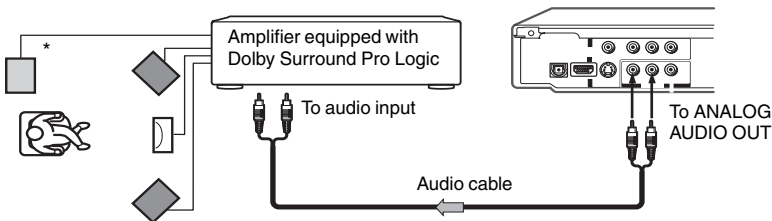

\* Connect one or two rear speakers. The output sound from the rear speakers will be monaural even if you connect two rear speakers.

## Connecting to an amplifier equipped with a DTS decoder

### Digital Theater Systems (DTS)

DTS is a high quality surround technology used in theaters and now available for home use, on DVD video discs or audio CDs.

If you have a DTS decoder or processor, you can obtain the full benefit of 5.1 channel DTS encoded sound tracks on DVD video discs or audio CDs.

“DTS” and “DTS Digital Out” are trademarks of Digital Theater Systems, Inc.

- Use DVD video discs or audio CDs encoded via the DTS recording system.
- Make the following setting.

On-screen display	Select:	Page
“Digital Out”	“Raw”	<b>50</b>
		<b>55</b>
Recording system	DTS	<b>41</b>

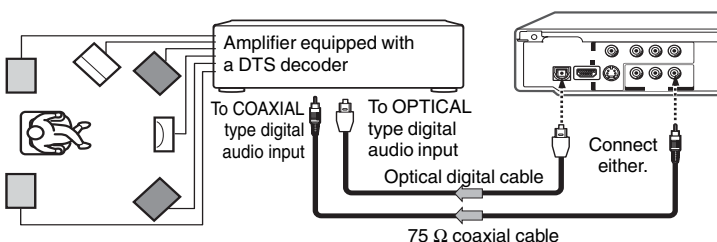

## Connecting to an amplifier equipped with an MPEG2 audio decoder

### MPEG2 sound

You can enjoy motion picture and live concert DVD video discs with dynamic realistic sound by connecting an amplifier equipped with an MPEG2 audio decoder or MPEG2 audio processor.

- Use DVD video discs encoded via the MPEG2 recording system.
- Make the following setting.

On-screen display	Select:	Page
“Digital Out”	“Raw” or “PCM”	<b>50</b>
		<b>55</b>
Recording system	MPEG2	<b>41</b>

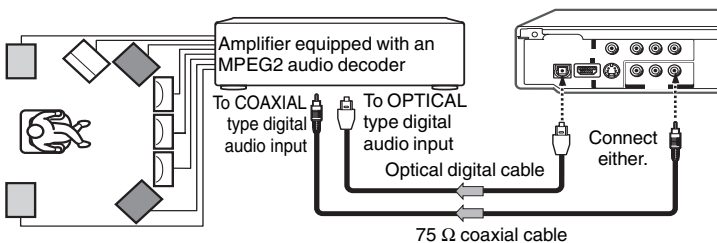

# Connecting to Optional Equipment (Continued)

## Connecting to an amplifier equipped with a digital audio input

### 2 channel digital stereo

You can enjoy the dynamic sound of 2 channel digital stereo by connecting an amplifier equipped with a digital audio input and speaker system (right and left front speakers).

- Make the following setting.

On-screen display	Select:	Page
"Digital Out"	"PCM"	50
		55

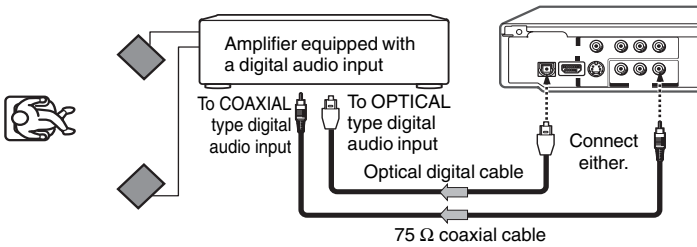

# **Basic playback**

Begin your operation.

- **Playing a Disc**
- **Variable Speed Playback**
- **Locating a Desired Section**



## Playing a Disc

This section shows you the basics on how to play a disc.

### CAUTION

Keep your fingers well clear of the disc tray as it is closing. Neglecting to do so may cause serious personal injury.

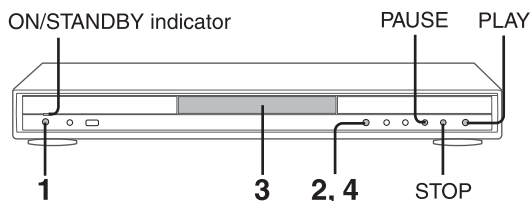

## Basic playback

### Preparations

- When you want to view a disc, turn on the TV and select the video input connected to the DVD video player.
- When you want to enjoy the sound of discs from the audio system, turn on the audio system and select the input connected to the DVD video player.
- Press DVD to select DVD mode.

### 1 Press the POWER button.

- POWER  
I/O
- The DVD video player turns on. The ON/STANDBY indicator on the player illuminates.

### 2 Press OPEN/CLOSE.

- OPEN/CLOSE
- The disc tray opens.

### 3 Place the disc on the disc tray.

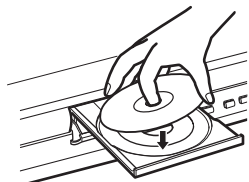

With the playback side down

- There are two different disc sizes. Place the disc in the correct guide on the disc tray. If the disc is out of the guide, it may damage the disc and cause the DVD video player to malfunction.
- Do not place a disc which is unplayable in this DVD video player.

### 4 Press OPEN/CLOSE to close the disc tray.

- OPEN/CLOSE Playback starts.



If you insert a DVD video disc that contains a top menu, a menu may appear. Use the ▲ / ▼ / ◀ / ▶ to select the title you want to view, then press ENTER to start playback. See "Locating a title using the top menu" [30](#).

- You may need to press the TOP MENU or MENU button to display disc menu (depending on the actual DVD video disc.)

### Notes

- If the disc tray is holding a disc you have already played, playback will begin from the location where you last stopped. For resuming playback, see [29](#).
- Some Video CD are recorded with **PBC (Playback Control)**, a menu with recorded contents may appear on the TV if you have turned the PBC on. You can make your selection according to its PBC menu. Press the **MENU** button on the remote control to turn PBC on or off anytime during Video CD playback. When switching from PBC on mode, playback will start from the beginning of the disc.

### ■ To start playback in the stop mode

Press **PLAY**.



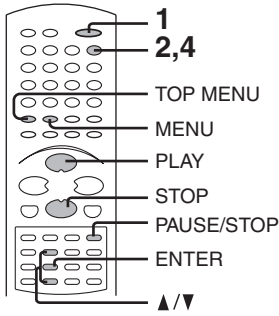

■ **To obtain a higher quality picture**

Occasionally, some picture noise not usually visible during a normal broadcast may appear on the TV screen while playing a DVD video disc because the high resolution pictures on these discs include a lot of information. While the amount of noise depends on the TV you use with this DVD video player, you should generally reduce the sharpness adjustment on your TV when viewing DVD video discs.

■ **About**

The icons on the heading bar show the playable discs for the function described under that heading.

: You can use this function with DVD video discs.

: You can use this function with VIDEO CDs.

: You can use this function with audio CDs.

■ **To pause playback (still mode)**

Press **PAUSE/STEP** during playback.



To resume normal playback, press the **PLAY** button.

- The sound is muted during still mode.

■ **To stop playback**

Press **STOP**.



■ **To remove the disc**

Press **OPEN/CLOSE**.



Remove the disc after the disc tray opens completely.

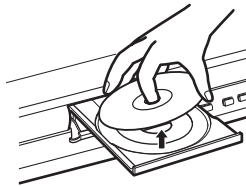

Be sure to press the **OPEN/CLOSE** button to close the disc tray after you remove the disc.

■ **To turn the power off (To enter the standby mode)**

Press **STANDBY/ON** button to turn the **STANDBY/ON** indicator off.

**Note**

Be aware that this equipment is still powered even after the **ON/STANDBY** indicator turns off (standby mode) by pressing the **ON/STANDBY** button. To disconnect this equipment completely from the mains power, pull out the power plug from the wall outlet.

■ **About the screen saver**

If you pause a picture of a DVD video disc and leave it still for a long while, the screen saver of the DVD video player automatically appears. To turn off the screen saver, press the **PLAY** button.

■ **Automatic Power Off function**

If the DVD video player is stopped, or the screen saver is engaged for approximately 20 minutes, the DVD video player will automatically turn itself off.

**Notes**

- Do not move the DVD video player during playback. Doing so may damage the disc.
- Use the **OPEN/CLOSE** button to open and close the disc tray. Do not push the disc tray while it is moving. Doing so may cause the DVD video player to malfunction.
- Do not push up on the disc tray or put any objects other than discs on the disc tray. Doing so may cause the DVD video player to malfunction.
- In many instances, a menu screen will appear after playback of a movie is completed. Prolonged display of an on-screen menu may damage your television set, permanently etching that image onto its screen. To avoid this, be sure to press the **STOP** button on your remote control once the movie is completed.



## Variable Speed Playback

You can play discs at various speeds, and resume playback from the location where you stopped playback.

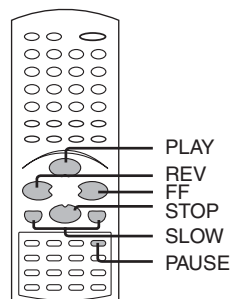

### DVD VCD CD Playing in fast reverse or fast forward directions

**Press REV or FF during playback.**



REV: Fast reverse playback  
FF: Fast forward playback

Each time you press the REV or FF button, the playback speed changes.

■ **To resume normal playback**

Press **PLAY**.



**Notes**

- The DVD video player mutes sound and subtitles during reverse and forward scan of DVD video discs. However, the DVD video player plays sound during fast forward or fast reverse play of audio CDs.
- The playback speed may differ depending on the disc.

### DVD VCD Playing frame by frame

**Press PAUSE/STEP during still playback.**

PAUSE/STEP



Each time you press the PAUSE/STEP button, the picture advances one frame.

■ **To resume normal playback**

Press **PLAY**.



**Note**

The sound is muted during frame by frame playback.

## Playing in slow-motion

### Press SLOW during playback.

Each time you press the SLOW button, the slow-motion speed changes in the following sequence:



▶ 1/2 → ▶ 1/4 → ▶ 1/8



◀ 1/2 → ◀ 1/4 → ◀ 1/8

### ■ To resume normal playback

Press **PLAY**.



#### Note

- The sound is muted during slow-motion playback.
- 3 speeds are available.

## Resuming playback from the same location

### 1 Press **STOP** at the location where you want to interrupt playback.



The DVD video player memorizes the location where playback is stopped.

### 2 Press **PLAY**.



The DVD video player resumes playback from the location where you stopped playback.

### ■ To start playback from the beginning regardless of the location where you stopped playback

1 Press **STOP** twice.



The DVD video player deletes the memory of the location.

2 Press **PLAY**.



 Playback starts from the beginning of the current title.

 Playback starts from the beginning of the disc.

- If you want to return to the beginning of a DVD video disc, open and close the disc tray once with the OPEN/CLOSE button before pressing the PLAY button.

#### Notes

- Resuming cannot function when:
  - you open the disc tray.
  - you disconnect the power plug of the DVD video player.
  - you play a PBC-featured video CD while the PBC is on.
- There may be a difference in the location where playback resumes depending on the disc.
- Settings you changed using the on-screen displays while the DVD video player keeps a location in the memory may function only after the memory is cleared.

# Locating a Desired Section

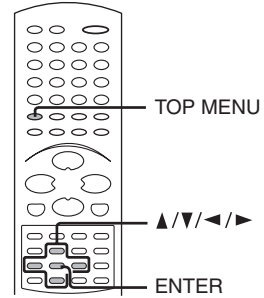

Normally, DVD video discs are divided into titles, and the titles are sub-divided into chapters. VIDEO CDs and audio CDs are divided into tracks. You can quickly locate any specific title, chapter, or track.

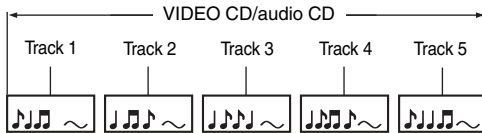
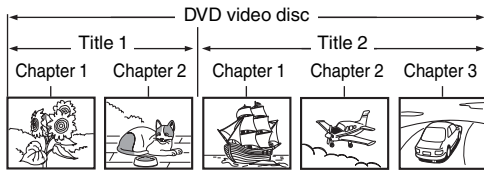

## DVD Locating a title using the top menu

### 1 Press TOP MENU.



The top menu appears on the TV screen.

e.g.

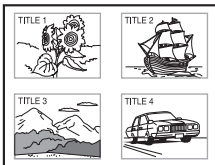

### 2 Press ▲/▼/◀/▶ to select the title you want.

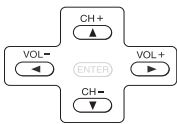

If the titles in the top menu are assigned a number, you can directly locate a specific title by pressing its designated number with the number buttons.

### 3 Press ENTER.

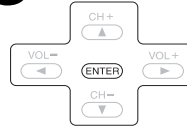

Playback starts from chapter 1 of the selected title.

#### Notes

- The instructions above describe basic procedures which may vary depending on the contents of the DVD video disc. If different instructions appear on the TV screen, follow those instructions.
- If you display the top menu during playback and press the TOP MENU button again without selecting any title, the DVD video player may resume playback from the point where you first pressed the TOP MENU button (depending on the actual DVD video disc.)
- This method of locating a title is available only on a disc that contains a top menu.
- Instruction notes of discs may refer to the button that displays the top menu as TITLE button.

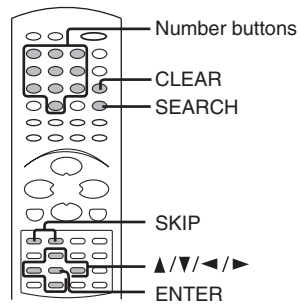

**DVD**  
**VCD**  
**CD** **Locating a desired section by entering the corresponding number**

**1 Press Search.**  
**Press ▲ / ▼ to highlight the Title/Chapter or Track.**

If you are using a VIDEO CD/audio CD, skip step 2. Then at step 3, enter the number for the track you want using the number buttons.

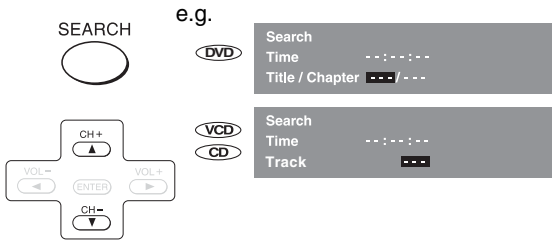

**3 Press the number buttons to enter title, chapter or track number.**

**4 Press ENTER.**

Playback starts from the selected section.

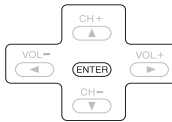

**2 Press ◀ / ▶ to select a section you want to locate.**

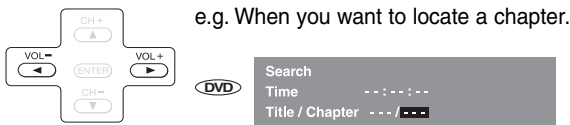

**Notes**

- Pressing the CLEAR button resets the numbers. To clear the display, press the SEARCH button several times.
- This method of locating a title is available only on a disc that contains title numbers.

**DVD**  
**VCD**  
**CD** **Locating a specific chapter or track**

**Press SKIP ◀◀ or ▶▶ repeatedly to access the chapter or track number you want.**

Playback starts from the selected chapter or track.

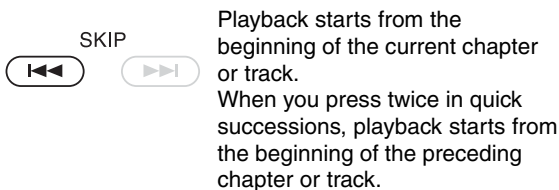
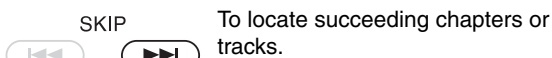

**Notes**

- Some titles may not display chapter numbers.
- If you press and hold the SKIP ◀◀ or ▶▶ button on the front panel during playback, the DVD video player performs fast reverse or fast forward playback. You can vary the speed by pressing the button repeatedly. To locate chapters or tracks during fast reverse or fast forward playback, first press the PLAY button to resume normal playback, then use the SKIP ◀◀ or ▶▶ button.



# Advanced playback

Customizing the performance of your DVD video player.

- **Accessing a Specific Location Directly**
- **Repeating Random Order**
- **Playing Repeatedly**
- **Playing in a Favorite Order**
- **Zooming a Picture**
- **Selecting the Camera Angle**
- **Selecting Subtitles**
- **Selecting a Language**
- **On-screen Display Operation**
- **Playing MP3/WMA Files**
- **Viewing JPEG Files**



# Accessing a Specific Location Directly

You can access a specific location by entering its corresponding time (hours, minutes, seconds)

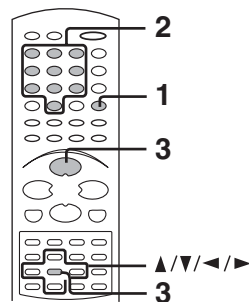

## DVD VCD CD Entering the time counter of the desired location

### 1 Press SEARCH

SEARCH Press ▲ / ▼ button to highlight the time counter.

e.g.

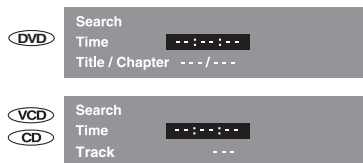

### 2 Press the number buttons to enter the time.

e.g. ① → ② → ⑤ → ③ → ①



- The first number you entered represent hour.
- The second two numbers you entered represent minutes.
- The third two numbers you entered represent seconds.
- If you input a wrong number, press CLEAR.

### 3 Press ENTER.

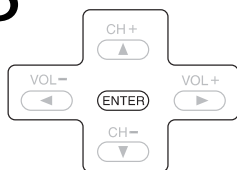

Playback starts from the desired location.

#### Notes

- Some discs may not respond to this process.
- Some scenes may not be located precisely as you specified.
- This method for accessing specific locations is available only within the current title of the DVD video disc or within the current track of the VIDEO CD / audio CD.

### ■ To set and play favorite bookmark during playback

1. Press SEARCH twice, the display of Bookmark appears, then press ENTER to mark the desired scene.

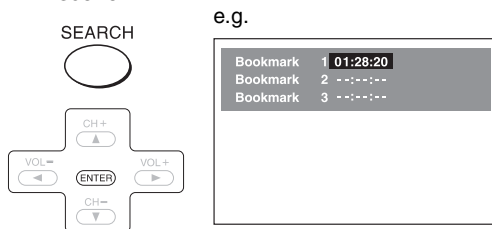

2. Press ENTER to play the favorite bookmark immediately.

### ■ To set other bookmarks.

Follow step 1 and move through the menu by pressing the ▲ or ▼ button.

### ■ Press SEARCH again to remove this display.



### ■ To cancel the Bookmark

Follow step 1, then press CLEAR to cancel the bookmark. Move through the menu by pressing the ▲ or ▼ button to cancel other bookmarks.

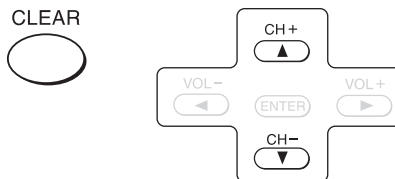

#### Notes

- Some discs may not work with marking operation.
- The marking is canceled when you open the disc tray or turn the power off.
- Some subtitles recorded around the marker may fail to appear.

# Playing in Random Order

You can play titles, chapters or tracks in random order.  
(Random playback)

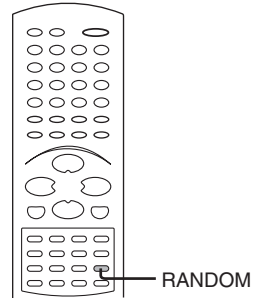

## Playing titles, chapters or tracks in random order

### 1 Press RANDOM during playback



The "Random On" appears. The DVD video player starts random playback within about 5 seconds after you press RANDOM button.



Random On  
↓  
Random Off

### ■ To resume normal playback

Press **RANDOM** repeatedly until the word "Random Off" is displayed.



#### Notes

- Some discs may not permit random playback operation.
- You cannot use the random playback function in conjunction with the program playback function.
- When "Random on" appears, PBC will be turned off automatically.

# Playing Repeatedly

You can play a specific title, chapter, track, or segment repeatedly.  
(Title repeat, chapter/track repeat, A-B repeat)

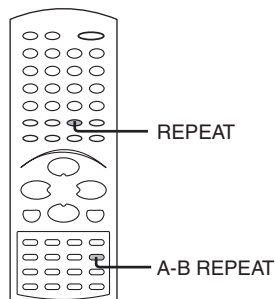

## DVD VCD CD Repeating a title, chapter or tracks

### 1 Press REPEAT repeatedly to select desired repeat mode during playback.

REPEAT Each time you press REPEAT button, the playback mode changes as follows:

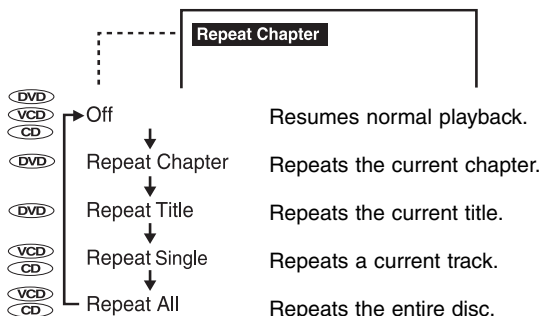

The DVD video player starts in the selected mode within 5 seconds after you select.

### To resume normal playback

Press REPEAT until the **Off** is displayed.

#### Notes

- Some discs may not permit these operations.
- Repeat is prohibited when PBC is on. **[26]**

## DVD VCD CD Repeating a specific segment

### 1 Press A-B REPEAT at the beginning of the segment (point A) you want to play repeatedly.



### 2 Press A-B REPEAT again at the end of the segment (point B).

The DVD video player automatically returns to point A and starts repeat playback of the selected segment (A-B).

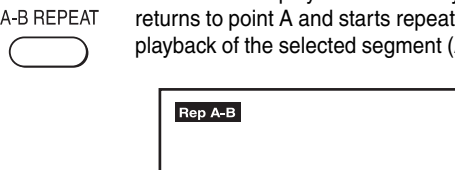

### To resume normal playback

Press A-B REPEAT until **Rep off** is displayed.



#### Notes

- Some discs may not permit A-B repeat operation.
- You cannot set the A-B repeat function for a segment that includes multiple camera angles **[39]**.
- You can specify a segment only within the current title or track (VIDEO CD).
- There may be a slight difference between point A and the location where playback actually resumes depending on the disc.

# Playing in a Favorite Order

You can combine your favorite titles, chapters, or tracks and play them in the order you determine. You can program up to 12 selections into the memory. (Program playback)

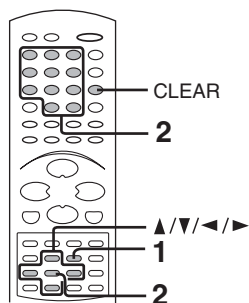

## Setting titles, chapters, or tracks in a favorite order

### 1 Insert a disc and press PROGRAM during stop.

The following display appears.

e.g.

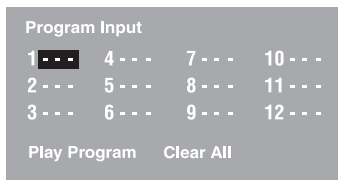
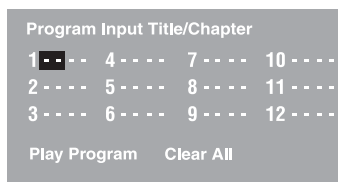

### 2 Select the items in the order you want by pressing the number buttons.

Each time you press the  $\blacktriangle$  /  $\blacktriangledown$  /  $\blacktriangleleft$  /  $\blacktriangleright$  button, the space is highlighted in turn. Highlight where you want to enter, then press the corresponding number buttons.

To select another chapter in the same title, you do not need to select the title number.

To select tracks from a VIDEO CD/audio CD in order, press the **number buttons** for the track.

### 3 Press $\blacktriangle$ / $\blacktriangledown$ / $\blacktriangleleft$ / $\blacktriangleright$ to move the highlighted bar to Play Program, then press the ENTER.

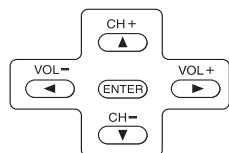

The DVD video player starts program playback.

#### ■ To change the programmed selections

- 1 While the display appears on the TV screen, press  $\blacktriangle$  /  $\blacktriangledown$  /  $\blacktriangleleft$  /  $\blacktriangleright$  to move the highlighted bar to the item you want to change.
- 2 Change the selection following the instructions in step 2.

#### ■ To cancel the programmed selections

- 1 Press the **PROGRAM** button, the display appears on the TV screen, press  $\blacktriangle$  /  $\blacktriangledown$  /  $\blacktriangleleft$  /  $\blacktriangleright$  to move the highlighted bar to the item you want to cancel.
- 2 Press **CLEAR**.

#### ■ To resume normal playback from program playback

Press **PROGRAM** button.

Press  $\blacktriangle$  /  $\blacktriangledown$  /  $\blacktriangleleft$  /  $\blacktriangleright$  to move the highlighted bar to **Clear All**, then press the **ENTER**. All the input programmes will be cleared.

Press **PLAY** button to resume normal playback.



Normal playback will start from first location.

#### ■ To program during playback

If you press the **PROGRAM** button during playback, a programming display appears. Follow steps 2 and 3.

#### Notes

- Some discs may not permit program playback operation.
- If you press the REPEAT button during program playback, the DVD video player repeats the current program playback.
- If you press the PROGRAM button while the display appears on the TV screen, the display disappears.
- The programmed selections will be cleared when you turn off the DVD video player.

# Zooming a Picture

You can magnify areas within a picture.

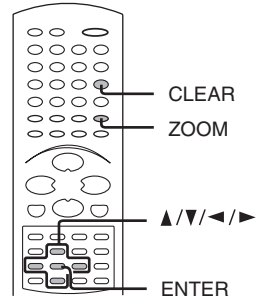
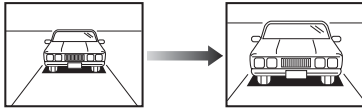

**DVD VCD** **Zooming a picture**

**Press ZOOM during normal, slow or still playback.**



The center part of the image will be zoomed in.

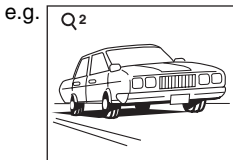

Each time you press the ZOOM button, the magnification level changes as follows:

Q 1 → Q 2 → Q 3 → Q off

Press the ZOOM button to select the magnificant level.

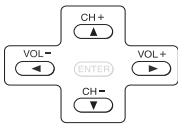

Press the ▲/▼/◀/▶ buttons to view a different part of the image. You may move the image from the center position to UP, DOWN, LEFT and RIGHT direction.

When you reach the edge of the image, the display will not shift anymore in that direction.

**Q off**



Press the ZOOM button repeatedly until the **Q off** is displayed.

**To resume normal playback**

Press ZOOM repeatedly until the **Q off** is displayed. Original picture is restored.



**Notes**

- Some discs may not respond to zoom feature.
- During some scenes, the buttons may not work as described.
- Zooming does not work on subtitles or menus included on DVD video discs.
- The magnification level varies depending on the picture size you select **54**.

## Selecting the Camera Angle

If the scene was recorded from multiple angles, you can easily change the camera angle of the scene you are watching.

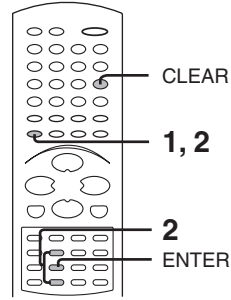
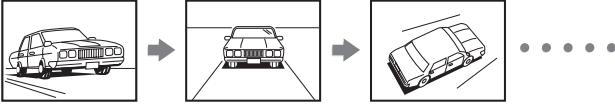

### DVD Changing the camera angle

#### 1 Press ANGLE while playing a scene recorded with multiple angles.



e.g.

While playing a scene recorded with multiple angles, press the ANGLE button.



Number changes to show the number of the current angle. (The maximum number of possible angles is 9)

#### 2 Press ANGLE while the angle number is displayed on the TV screen.



Press the ANGLE button repeatedly to change the scene to the next angle in those recorded.

- About two seconds later, playback continues from the new angle you selected.
- If no button is pressed within 6 seconds, playback continues without changing the current angle.

#### ■ To resume normal playback

Press the ANGLE repeatedly until the “ 1/3 ” is displayed.

#### Notes:

- This function can only be used for discs on which scenes shot from multiple angles have been recorded.
- If only one angle is recorded, “ 1/1 ” is displayed.

## Selecting Subtitles

You can display subtitles on the TV screen and select a subtitle language from those included on the DVD video disc.

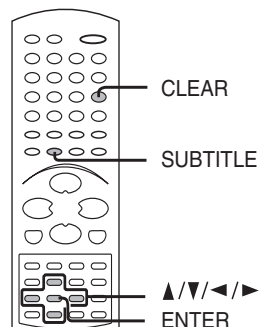

### DVD Selecting a subtitle language

#### 1 Press SUBTITLE during playback.

SUBTITLE The current subtitle setting is displayed.

e.g.



#### ■ To turn subtitles on or off

1 Press SUBTITLE during playback.



2 Press SUBTITLE repeatedly until the Off icon is displayed.

#### Notes

- Some DVD video discs are set to display subtitles automatically, and you cannot turn them off even if you set the subtitle function to off.
- During some scenes, the subtitles may not appear immediately after you select your desired.
- Some DVD video discs will allow you to make subtitle selections and turn subtitles on or off only via the disc menu.

#### 2 Press SUBTITLE while the subtitle setting is displayed on the TV screen.

SUBTITLE Each time you press the SUBTITLE button, the subtitle languages included on the DVD video disc change.



To turn off the subtitle setting display, press the SUBTITLE button repeatedly until Off is displayed.

#### Notes

- When you turn on the DVD video player or replace a disc, the player returns to the initial default setting. When you select a subtitle language which is not included on the disc, the DVD video player plays a prior language programmed on the disc.
- During some scenes, the subtitles may not appear immediately after you change the subtitle language.

# Selecting a Language

You can select a preferred language and sound recording system from those included on the DVD video disc.

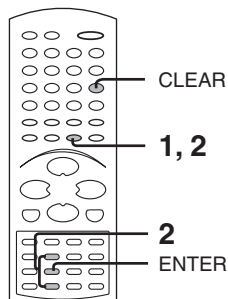
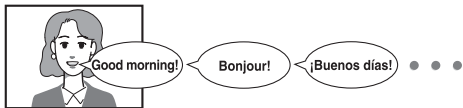

## DVD VCD Selecting a playback audio setting

### 1 Press AUDIO during playback.

**AUDIO** The current audio setting is displayed.



e.g.

1/3 D6 Ch Fre

Recorded audio format number changes sequentially. (The maximum number of possible audio formats is 8)

The abbreviation of the language appears instead of the language name. Refer to the list of languages and their abbreviations. [57](#)

### 2 Press AUDIO while the audio setting is displayed on the TV screen.



Each time you press the AUDIO button, the audio settings included on the DVD video disc change.

#### Notes

- When you turn on the DVD video player or replace a disc, player returns to the initial default setting [53](#). If you select a sound track which is not included on the disc, the DVD video player plays a prior sound track programmed on the disc.
- Some discs allow you to change audio selections only via the disc menu. If this is the case, press the MENU button and choose the appropriate language from the selections on the disc menu.

### Selecting sound channels of VIDEO CDs



Press AUDIO repeatedly during playback to hear a different audio channel (stereo, Left or Right).

### Output sound conversion table

Input \ Output		OPTICAL / COAXIAL DIGITAL AUDIO OUT jack		ANALOG AUDIO OUT Jacks
		"Digital Out"	"Raw"	
DVD video disc	Dolby Digital	Raw	PCM	○
	Linear PCM	PCM	PCM	○
	DTS	Raw	Raw	—
	MPEG1, MPEG2	Raw	PCM	○
VIDEO CD	MPEG1	PCM	PCM	○
Audio CD	Linear PCM 44.1 kHz/16 bit	PCM	PCM	○
	DTS	Raw	Raw	—
MP3/WMA		PCM	PCM	○

- Quantization bit of signals of 20 bit or higher which is output from the OPTICAL or COAXIAL DIGITAL AUDIO OUT jack is 16 bit if they are in a copyright protected disc.



# On-screen Display Operation

When you turn on the on-screen display, you can view information on operational status and access features and settings.

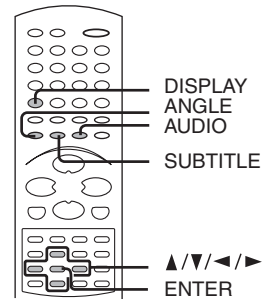

## DVD VCD CD On-screen display operation

### ■ Viewing the operational status

- 1 Press **DISPLAY**.  
The following display appears.

Time counter  
 DVD Elapsed time / remaining time of the current title  
 VCD Elapsed time / remaining time of the current track  
 CD

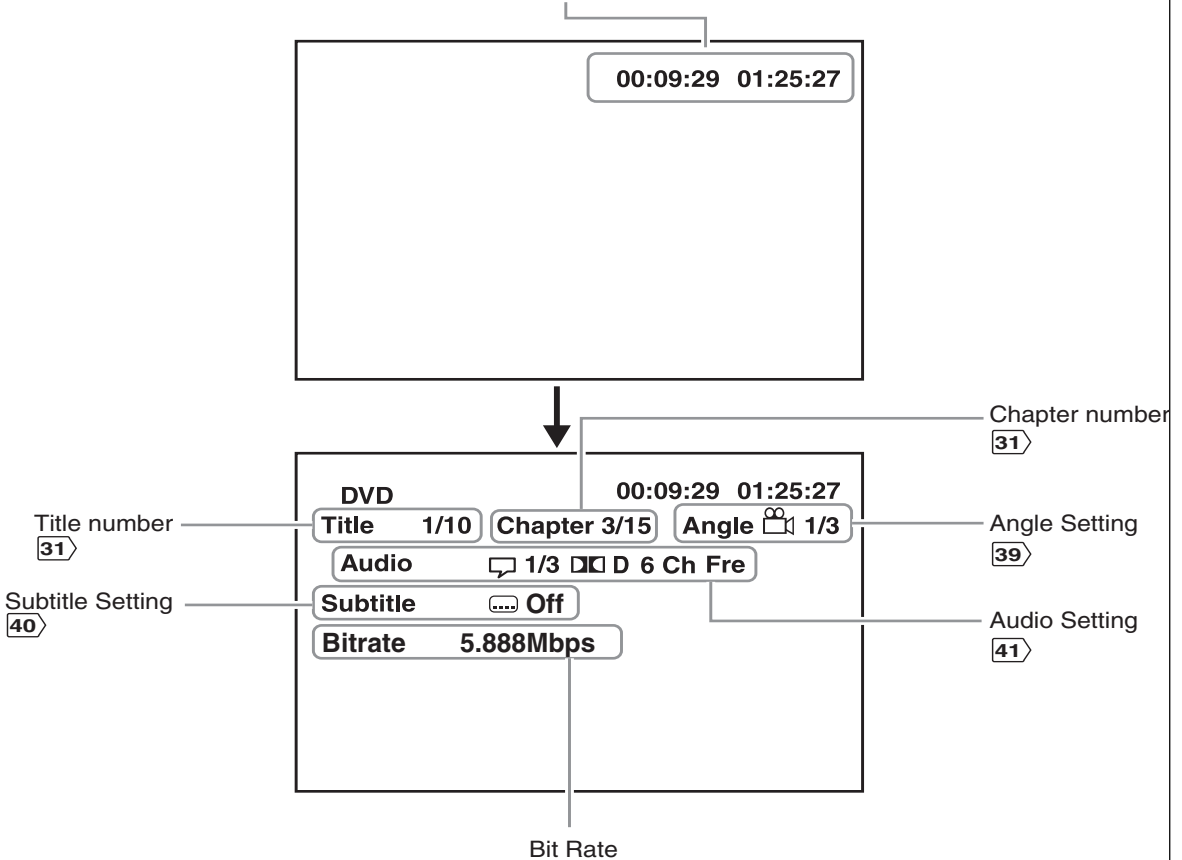

- 2 To turn off the display, press **DISPLAY** again.

### Bit rate (Mbit/s)

Amount of picture, sound and subtitle data in the DVD video disc transferred per second. The larger the value is, the more data processed, but this does not necessarily insure better picture quality.

# Playing MP3/WMA Files

You can play MP3/WMA files that have been recorded on a CD-R or CD-ROM on the DVD video player.

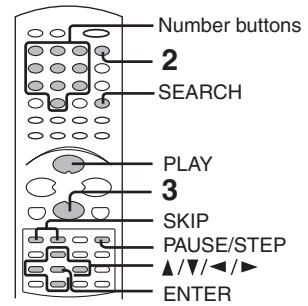

## Playing MP3/WMA files

### ■ Preparations

- Make sure that a disc you want to play is compatible with this DVD video player. [47](#)

**1** Place a CD that contains MP3/WMA files on the disc tray.

**2** Press OPEN/CLOSE to load the disc.

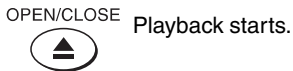

**3** To stop playback, press STOP.



### ■ Selecting a track (file) in the disc

- 1 Press **SEARCH**.
- 2 Enter the track number to select a track you want to play.
- 3 Press **ENTER** to begin playback of the selected track.  
The current track being played is highlighted in green.

#### Notes

- Letters of a file/folder name overflowing the given space are not displayed.
- You can not play in Fast reverse or Fast forward during MP3/WMA playback.

### ■ To pause playback

Press **PAUSE/STEP** during playback.



To resume normal playback, press the **PLAY** button.

#### Notes

- Some discs may not permit this operation.
- WMA tracks copy-protected cannot be played.
- The OPTICAL or COAXIAL DIGITAL AUDIO OUT jack outputs MP3/WMA sounds in the linear PCM format regardless of the current "Digital Out" selection.
- If you stop playback by pressing the STOP button, and then press the PLAY button, playback will start from the beginning of the track.
- The SKIP [31](#) and PROGRAM [37](#) functions are also available.

## ■ Playable files

MP3/WMA disc compatibility with this player is limited as follows:

- Playable discs: CD-ROM, CD-R (650MB / 74 min. only)  
CD-RW is not recommendable.
- Sampling Frequency: 44.1 kHz only
- Bit rate: WMA: 48 kbps - 192 kbps (CBR) \*  
MP3: 32 kbps - 320 kbps (CBR) \*
- CD physical format: Mode 1, Mode 2 XA Form 1
- File system: ISO9660 Level 1, 2 or Joliet
- File name: A file name should be in alphabet and numerals only, and must incorporate "MP3" or "WMA" extension.  
e.g. "\*\*\*\*\*.MP3", "\*\*\*\*\*.WMA"
- Total number of folders: Less than 256
- Total number of files: Less than 1000
- WMA codec version: V7 or V8 (Stereo sound only)

\* CBR = Constant Bit Rate

This DVD video player requires discs/recordings to meet certain technical standards in order to achieve optimal playback quality. Pre-recorded DVDs are automatically set to these standards. There are many different types of recordable disc formats (including CD-R containing MP3/WMA files). Given the fact that technology in this area is still maturing, Toshiba cannot guarantee that all genre of recordable discs will produce optimal playback quality. The technical criteria set out in this owner's manual are meant as a guide only.

Customers should also note that permission is required in order to download MP3 files and music from the internet. Toshiba has no right to grant such permission. Permission should always be sought from the copyright owner.

Microsoft, Windows Media, and the Windows Logo are trademarks or registered trademarks of Microsoft Corporation in both the United States and other countries.



### Note

When the WMA or MP3 file is out of the above specifications, the song may be skipped or muted with counter moving.

# Viewing JPEG Files

You can play JPEG files that have been recorded on a CD-R or CD-ROM on the DVD video player. You can select a preferred view: a page of 9 thumbnail images or a single image view. Also, rotating, enlarging and shifting of each image can be possible.

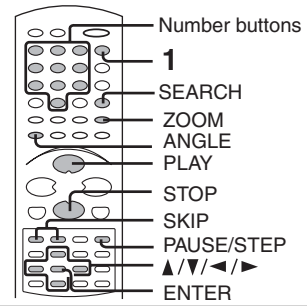

## Viewing JPEG files

### ■ Preparations

- Prepare a disc that contains JPEG files you want to view.
- Make your TV shape conform to the 4:3 picture size. Only 4:3 pictures can be played regardless of the function settings via the on-screen displays of the DVD video player. If the TV is adjusted to other sizes, e.g. "WIDE," images will appear to be horizontally expanded. For details, refer to the owner's manual of your TV.

### 1 Press OPEN/CLOSE to open the disc tray, place a disc that contains JPEG files.

**OPEN/CLOSE** Press OPEN/CLOSE to close the disc tray, after completion of reading, playback automatically starts. The next picture will automatically display after a few seconds.



A view appears. (Automatic mode) e.g.

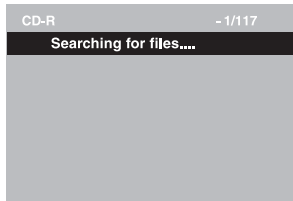

A list of folders in the disc appears. (Selection mode) e.g.

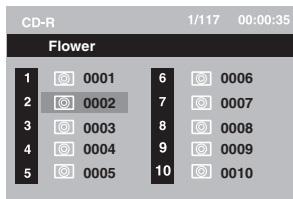

Press **▲/▼/◀/▶** to select your desired file, and then press **ENTER** or **PLAY** button to start playback. Press **STOP** to display a folder list.



**SEARCH**



Press **SEARCH** and enter the track number to quickly select your image.

e.g.

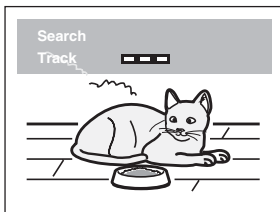

### ■ To quit the JPEG playback, press STOP.



- Pressing the OPEN/CLOSE button to open the disc tray can also quit the playback.

### ■ To pause playback

Press **PAUSE/STEP** during playback

**PAUSE/STEP**



To resume normal playback, press **PLAY**.

### ■ To change the image

**SKIP** To view the succeeding image, press **SKIP ▶▶**.



**SKIP** To view the previous image, press **SKIP ◀◀**.



### ■ To magnify image

Press **ZOOM** repeatedly.

**ZOOM**



Each time you press the **ZOOM** button, the magnification level changes as follows:

Q 1 → Q 2 → Q 3 → Q off

Press the **▲/▼/◀/▶** buttons to view a different part of the image. You may move the image from the center position to UP, DOWN, LEFT and RIGHT direction. When you reach the edge of the image, the display will not shift anymore in that direction.

### ■ To resume normal playback

Press the **ZOOM** repeatedly until the **Q off** is displayed.

**ZOOM**



- Original picture is restored when the **Q off** appears.
- Some files may not display their own entire depending on the size.

### ■ To rotate an image

Press the **ANGLE** repeatedly

**ANGLE**

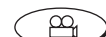

The image rotates by clockwise 90-degree.

# Viewing JPEG Files (Continued)

## Viewing a thumbnail view

### 1 Press TOP MENU in full-screen review.



To view the previous 9 images.

To view the succeeding 9 images.

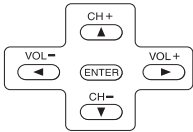

Press the ▲ / ▼ / ◀ / ▶ to select an image, press PLAY to view one image in full-screen and automatically images will be displayed one by one again in a few seconds.

### ■ Turn the page if necessary

Press ▲ / ▼ / ◀ / ▶ to highlight the PREV ◀◀ or NEXT ▶▶ and ENTER to review other thumbnail screen.

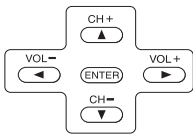

### ■ To quit the JPEG playback, press STOP.



- Pressing the OPEN/CLOSE button to open the disc tray can also quit the playback.

### ■ To pause playback

Press PAUSE/STEP during playback



To resume normal playback, press PLAY.

### Notes

- Some files may not display their own entire depending on the size.
- If you press the TOP MENU in full-screen review, the DVD video player will display a menu of 9 thumbnail images.

## JPEG files compatibility

Discs whose compatibility with this DVD video player has been confirmed by TOSHIBA are as follows.

Many of these discs, when loaded, will make the DVD video player enter the automatic mode  to play a prescribed folder in the disc. To play other folders, display a folder list and select a folder.

CANON QuickCD  
FUJICOLOR CD  
Kodak Picture CD  
NORITSU QSS CD

JPEG disc compatibility with this DVD video player is limited as follows:

- Playable discs: CD-ROM, CD-R (650MB / 74 min. only)  
CD-RW is not recommendable.
- CD physical format: Mode 1, Mode 2 XA Form 1
- File system: ISO9660 Level 1, 2 or Joliet
- File name: A file name should be in alphabet and numerals only, and must incorporate "JPG" extension.  
e.g. "\*\*\*\*\*.JPG" (Do not name the file with "JPE" or "JPEG" extension.)
- Total number of folders: Less than 256
- Total number of files: Less than 1000

Some files may not display their own entire image depending on the size.

Some discs may not permit this operation. Especially, the following conditions of included files will increase the disc's disability.

1. Pixels over 3072 x 2048 in height and/or width
2. File format except Exif

# Function setup

You can change the default settings to customize performance to your preference.

- **Customizing the Function Settings**
- **Table of Languages**

# Customizing the Function Settings

You can change the default settings to customize performance to your preference.

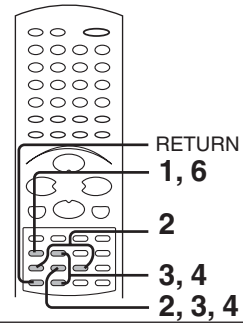

DVD VCD CD **Setting procedure**

## 1 Press SETUP during stop.



The following on-screen display appears.

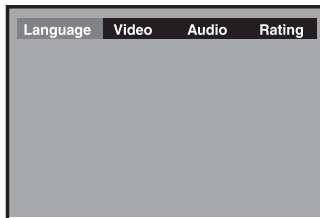

## 2 Press ◀/▶ to select a symbol for the setting you want to change, then press ENTER.

(See the next page.)

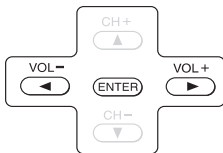

**Language settings**

**Video settings**

**Audio settings**

**Rating settings**

## 3 Press ▲/▼ to select the setting you want to change, then press ENTER.

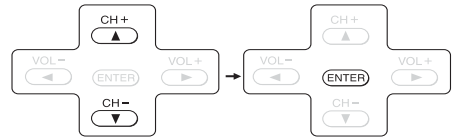

## 4 Change the selection by ▲/▼ buttons, by referring to the corresponding pages, then press ENTER.

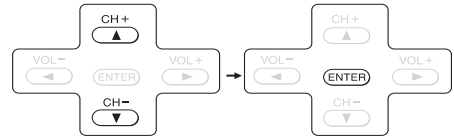

## 5 Repeat steps 3 and 4 to change other settings.

To select another operation, press RETURN to go back to step 2.

## 6 Press SETUP.



The on-screen display disappears.



















■ To return to the previous display Press RETURN.



### Notes

- To quit the procedure, press the SETUP button to turn off the on-screen display.



Setting		Details	Page
<b>Language</b>	<b>OSD Menu</b>	  	To select a preferred language for on-screen display. 52
	<b>Subtitle</b>		To select a preferred language for subtitles. 52
	<b>Audio</b>		To select a preferred language for the sound track. 53
	<b>DVD Menu</b>		To select a preferred language for disc menus. 53
<b>Video</b>	<b>TV Shape</b>		To select a picture size according to aspect ratio of your TV. 54
	<b>Video Output</b>	  	To select whether you send CVBS and YUV signals to the connected TV or not when you in analog mode 54
<b>Audio</b>	<b>Digital Output</b>	  	To select an output sound format corresponding to your system connection. 55
<b>Rating</b>	<b>Password</b>		To create a personal security code. 55
	<b>Rating</b>		To turn the parental lock function on or off. 55
	<b>Load Factory</b>	  	To return the initial settings such as Language, Video, Audio and etc. to the factory default. 56

# Customizing the Function Settings (continued)

## Setting details

### Language



### OSD Menu

DVD VCD CD

English: To view on-screen displays in English.  
 Français: To view on-screen displays in French.  
 Español: To view on-screen displays in Spanish.

- 1) Press ENTER.
- 2) Press ▲ / ▼ to select the OSD Menu.
- 3) Press ENTER button, then the ▲ / ▼ to shift and change the Language.
- 4) Press ENTER.
- 5) Press RETURN.



**Note**

Some DVD video discs may not include your pre-selected language. In this case, the DVD video player automatically displays disc menus consistent with the disc's initial language setting.

### Subtitle

DVD

English: To display subtitles in English.  
 Français: To display subtitles in French.  
 Español: To display subtitles in Spanish.  
 Auto: To display subtitles in different languages other than you selected.  
 Off: To disable subtitles.

- 1) Press ENTER.
- 2) Press ▲ / ▼ to select the Subtitle.
- 3) Press ENTER button, then the ▲ / ▼ to shift and change the Language.
- 4) Press ENTER.
- 5) Press RETURN.

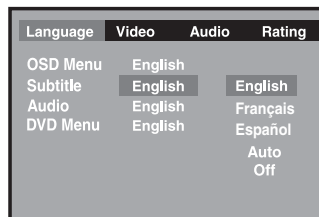

**Notes**

- Some DVD video discs may be set to display subtitles in a different language other than you selected. A prior subtitle language may be programmed on the disc.
- Some DVD video discs allow you to change subtitle selections only via the disc menu. If this is the case, press the MENU button and choose the appropriate subtitle language from the selection on the disc menu.

**Audio**

DVD

English: To play sound tracks in English.  
 Français: To play sound tracks in French.  
 Español: To play sound tracks in Spanish.

- 1) Press ENTER.
- 2) Press ▲ / ▼ to select the AUDIO.
- 3) Press ENTER button, then the ▲ / ▼ to shift and change the Language.
- 4) Press ENTER.
- 5) Press RETURN.

Language	Video	Audio	Rating
OSD Menu	English		
Subtitle	English		
Audio	English	English	
DVD Menu	English	Français	Español

**Note**

Some DVD video discs may not be played in a different language than you selected. A prior language may be programmed on the disc.

**DVD Menu**

DVD

English: To display DVD menus in English.  
 Français: To display DVD menus in French.  
 Español: To display DVD menus in Spanish.

- 1) Press ENTER.
- 2) Press ▲ / ▼ to select the DVD menu.
- 3) Press ENTER button, then the ▲ / ▼ to shift and change the Language.
- 4) Press ENTER.
- 5) Press RETURN.

Language	Video	Audio	Rating
OSD Menu	English		
Subtitle	English		
Audio	English		
DVD Menu	English	English	Français
			Español

**Note**

Some DVD video discs may not include your pre-selected language. In this case, the DVD video player automatically displays disc menus consistent with the disc's initial language setting.

# Customizing the Function Settings (continued)

## Setting details

### Video

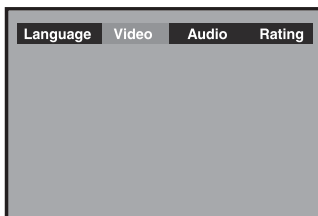

### TV Shape DVD

- 1) Press ◀/▶ to select the Video.
- 2) Press ENTER.
- 3) Press ENTER button, then press the ▲/▼ to shift and change the TV type
- 4) Press ENTER.
- 5) Press RETURN.

**4:3 Pan Scan:** Select when a standard 4:3 TV is connected.



Displays pictures cropped to fill your TV screen. Either or both sides of the picture are cut off.

**4:3 Letterbox:** Select when a standard 4:3 TV is connected.

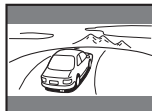

Displays theatrical images with masking bars above and below the picture.

**16:9 Widescreen:** Select when a 16:9 wide TV is connected.

#### Notes

- The displayable picture size is preset on the DVD video disc. Therefore, the playback picture of some DVD video discs may not conform to the picture size you select.
- When you play DVD video discs recorded in the 4:3 picture size only, the playback picture always appears in the 4:3 picture size regardless of the TV shape setting.
- If you select "16:9 Widescreen" and you own a 4:3 TV set, the DVD playback picture will be horizontally distorted during playback. Images will appear to be horizontally compressed. Always be sure that your TV shape conforms to the actual TV in use.

### Video Output

DVD VCD CD

- 1) Press ◀/▶ to select the Video.
- 2) Press ENTER.
- 3) Press ▲/▼ to select the Video Output.
- 4) Press ENTER button, then press ▲/▼ to select the output mode.
- 5) Press ENTER.
- 6) Press RETURN.

#### ANALOG mode

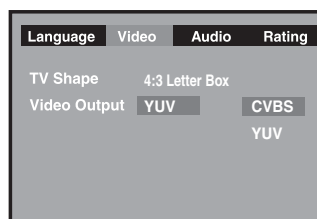

#### HDMI mode

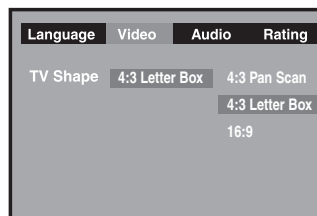

On Analog mode, you can select between CVBS and YUV:

- CVBS:** Select if you connect the DVD to TV via composite video input or S-VIDEO input.
- YUV:** Corresponding to your TV which has a YUV (component video) inputs.

On HDMI mode, there is no video output selection, it has been set to YUV already.

#### Note

At YUV mode, there is no S-VIDEO output.

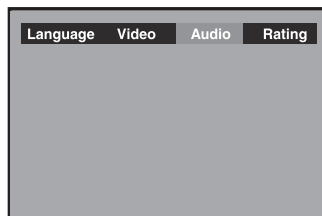
**Audio****Digital Out**

**DVD** **VCD** **CD**

Selected the output sound format corresponding to your system connection.

- 1) Press ◀/▶ to select Audio.
- 2) Press ENTER.
- 3) Press ENTER button, then press ▲/▼ to shift and change the output sound format.

**PCM:** Select when connected to a 2 channel digital stereo amplifier.

The DVD video player outputs sounds in the PCM 2 channel format when you play a DVD video disc recorded on the Dolby Digital, MPEG1 OR MPEG2 recording system.

**Raw:** Does not have a Dolby Digital Decode.

**Notes**

- When you make a connection to a TV, or Dolby Surround Pro Logic or stereo system via the analog audio jacks, select "PCM" or "Raw".
- If apply HDMI connection to TV, make sure to select "PCM", audio signal passing to TV via HDMI cable.

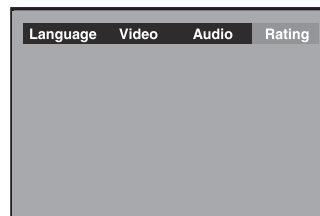
**Rating****Password / Rating**

**DVD**

DVD discs equipped with the password function are rated according to their content. The contents allowed by a parental lock level and the way a DVD disc can be controlled may vary from disc to disc.

For example, if the disc allowed, you could edit out violent scenes unsuitable for children and replace them with more suitable scenes, or you could lock out playback of the disc altogether.

- DVD video discs may or may not respond to the parental lock settings. This is not a defect in the DVD video player. Make sure this function works with your DVD video discs.
- 1) Press ◀/▶ to select the Rating.
  - 2) Press ENTER.
  - 3) Press ▲/▼ to select Rating and then press ENTER repeatedly to set the parental lock level.
  - 4) Press ▲ to the Password and enter your 4-digits security code, then press ENTER button.
  - 5) Press RETURN.

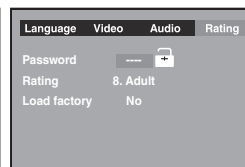
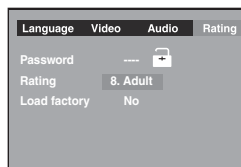
**Notes**

- If you make a mistake before pressing ENTER button, press CLEAR button and enter your 4-digit security code again.
- You cannot play DVD discs rated higher than the level you selected unless you cancel the parental lock function.

(continued)

## Customizing the Function Settings (continued)

### Setting details

(continued)

The parental lock level is equivalent to the following ratings:

- Level 1: Kid Safe
- Level 2: G
- Level 3: PG
- Level 4: PG-13
- Level 5: PG-R
- Level 6: R
- Level 7: NC-17
- Level 8: Adult



Indicates Parental lock is not active.



The Parental lock is active.

**If you forget the password, you can erase your current password by pressing number button 8 on the remote four times, then press ENTER button to confirm the setting.**

**PASSWORD: 8888**

### Load factory DVD VCD CD

If you want to return the initial settings such as Language, Video, Audio and etc. to the factory default, do the following:

- 1) Press ▲ / ▼ to select the Load factory.
- 2) Press ENTER.
- 3) Press ▲ / ▼ to select Yes, then press ENTER button.
- 4) Press ENTER.

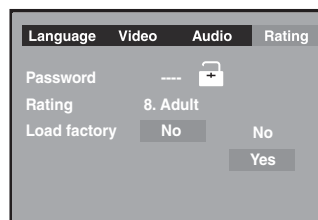

#### Note

When you reset the DVD video player to the factory default, the DVD video player will take 3-5 seconds to reset.

# Table of Languages

**Table of languages and their abbreviations**

Abbreviation	Language	Abbreviation	Language	Abbreviation	Language
---	No alternate language	GN	Guarani	PT	Portuguese
CHI (ZH)	Chinese	GU	Gujarati	QU	Quechua
DUT (NL)	Dutch	HA	Hausa	RM	Rhaeto-Romance
ENG (EN)	English	HI	Hindi	RN	Kirundi
FRE (FR)	French	HR	Croatian	RO	Rumanian
GER (DE)	German	HU	Hungarian	RU	Russian
ITA (IT)	Italian	HY	Armenian	RW	Kinyarwanda
JPN (JA)	Japanese	IA	Interlingua	SA	Sanskrit
KOR (KO)	Korean	IE	Interlingue	SD	Sindhi
MAY (MS)	Malay	IK	Inupiak	SG	Sango
SPA (ES)	Spanish	IN	Indonesian	SH	Serbo-Croatian
AA	Afar	IS	Icelandic	SI	Singhalese
AB	Abkhazian	IW	Hebrew	SK	Slovak
AF	Afrikaans	JI	Yiddish	SL	Slovenian
AM	Amharic	JW	Javanese	SM	Samoan
AR	Arabic	KA	Georgian	SN	Shona
AS	Assamese	KK	Kazakh	SO	Somali
AY	Aymara	KL	Greenlandic	SQ	Albanian
AZ	Azerbaijani	KM	Cambodian	SR	Serbian
BA	Bashkir	KN	Kannada	SS	Siswati
BE	Belorussian	KS	Kashmiri	ST	Sesotho
BG	Bulgarian	KU	Kurdish	SU	Sundanese
BH	Bihari	KY	Kirghiz	SV	Swedish
BI	Bislama	LA	Latin	SW	Swahili
BN	Bengali, Bangla	LN	Lingala	TA	Tamil
BO	Tibetan	LO	Laotian	TE	Telugu
BR	Breton	LT	Lithuanian	TG	Tajik
CA	Catalan	LV	Latvian, Lettish	TH	Thai
CO	Corsican	MG	Malagasy	TI	Tigrinya
CS	Czech	MI	Maori	TK	Turkmen
CY	Welsh	MK	Macedonian	TL	Tagalog
DA	Danish	ML	Malayalam	TN	Setswana
DZ	Bhutani	MN	Mongolian	TO	Tongan
EL	Greek	MO	Moldavian	TR	Turkish
EO	Esperanto	MR	Marathi	TS	Tsonga
ET	Estonian	MT	Maltese	TT	Tatar
EU	Basque	MY	Burmese	TW	Twi
FA	Persian	NA	Nauru	UK	Ukrainian
FI	Finnish	NE	Nepali	UR	Urdu
FJ	Fiji	NO	Norwegian	UZ	Uzbek
FO	Faroese	OC	Occitan	VI	Vietnamese
FY	Frisian	OM	(Afan) Oromo	VO	Volapük
GA	Irish	OR	Oriya	WO	Wolof
GD	Scottish Gaelic	PA	Panjabi	XH	Xhosa
GL	Galician	PL	Polish	YO	Yoruba
		PS	Pashto, Pushto	ZU	Zulu

# Others

- **Operating a TV with the Remote Control**
- **Before Calling Service Personnel**
- **Specifications**
- **Limited United States Warranty**
- **Canadian Warranty Information**



## Operating a TV with the Remote Control

You can operate the basic functions of selected TVs using the supplied remote control

### Operating a TV with the remote control

#### Preparation

Follow the instruction of "To program the remote control" to set the brand code.

#### Point the remote control at your TV, and use buttons as follows.

POWER	To turn the TV on or off.
INPUT SELECT	To select external source such as a VCR.
NUMBER buttons	To select TV channel. When selecting channels 1 to 9, first enter 0 and then the desired number.
100	To substitute for 100 channel key.
DISPLAY	To turn on or off TV's screen display.
VOL + / -	To adjust the volume.
CH + / -	To select a channel.
ENTER	To use for the TV's ENTER key.

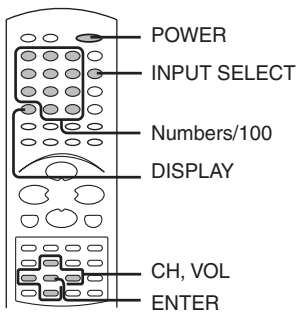

#### ■ To program the remote control

1. Press **TV** to select TV mode.
2. While holding down **PROGRAM** enter the two digits of your TV's brand code (listed on page 61) using **Number** buttons.

e.g. To program brand code 01.



3. Release **PROGRAM**.

The DVD remote control memorizes the selected TV brand code.

#### Notes

- The remote control is programmed at the factory to operate TOSHIBA TVs.
- A single brand may use different codes depending on the particular model. Enter the correct number referring to the brand code table.
- For some brands, several brand codes are provided. Try each of them until the remote control operates your TV.
- Some TVs may not respond to all of the functions in the table above, or may not be operated at all with this remote control.
- If you replace the remote control's batteries, remember to reprogram the brand codes for TV.
- To resume DVD functions, press DVD button once.

■ Brand code table

Brand Name	Brand Code					Brand Name	Brand Code				
TOSHIBA	01					PHILCO	10				
BELL & HOWELL	09					PHILIPS	10				
CARVER	10					PIONEER	16				
CELEBRITY	03					PRINCECLUB	12				
CITIZEN	12					PRISM	07				
CURTIS MATHES	09	12				PROSCAN	02				
DUMONT	14					PROTON	11				
ELECTRO BRAND	03					PULSAR	14				
EMERSON	09	11				QUASAR	07	15			
FISHER	09					RADIO SHACK	13				
GE	02	07	11			RCA	02				
GIBRALTER	14					REALISTIC	09	11	13		
GOLDSTAR	11					RUNCO (NEC)	14				
HALLMARK	11					SAMSUNG	11	12			
HITACHI	06					SANYO	09				
INFINITY	10					SCOTCH	11				
JBL	10					SCOTT	11				
JCB	03					SEARS	01	02	09	10	11
JVC	05					SHARP	08	13			
LXI	01	02	09	10	11	SONY	03				
MAGNAVOX	10					SOUNDESIGN	11				
MARANTZ	10					SUPREME	03				
MEGATRON	06	11				SYLVANIA	10				
MEMOREX	04	09	11			TANDY	08				
MGA	04	11				TECHNICS	07	15			
MIDLAND	02	07	14			TECHWOOD	07				
mitsubishi	04	11				TEKNIKA	04	10	12		
MOTOROLA	08					TMK	11				
MTC	12					VICTOR	05				
NAD	01	11				VIDIKRON	10				
NIKKO	11					VIDTECH	11				
OPTIMUS	09					WARDS	10	11	13		
OPTONICA	08					ZENITH	14				
PANASONIC	07	10	15								
PENNEY	01	02	07	11	12						

Others

## Before Calling Service Personnel

Check the following guide for the possible cause of a problem before contacting service.

### Symptoms and correction

Symptom	Cause	Correction	Page
No power.	<ul style="list-style-type: none"> <li>The power plug is disconnected.</li> </ul>	<ul style="list-style-type: none"> <li>Connect the power plug securely into the wall outlet.</li> </ul>	18
The DVD video player turned off by itself.	<ul style="list-style-type: none"> <li>The automatic power off function turned the unit off.</li> </ul>	<ul style="list-style-type: none"> <li>Press the PLAY button.</li> </ul>	27
No picture or abnormal color (pinkish, greenish, etc.).	<ul style="list-style-type: none"> <li>The TV is not set to receive DVD signal output.</li> </ul>	<ul style="list-style-type: none"> <li>Select the appropriate video input mode on the TV so the picture from the DVD video player appears on the TV screen.</li> </ul>	26
	<ul style="list-style-type: none"> <li>The video/HDMI cable is not connected securely.</li> </ul>	<ul style="list-style-type: none"> <li>Connect the video cable securely into the appropriate jacks.</li> </ul>	18-20
	<ul style="list-style-type: none"> <li>Video switch not set to correct position.</li> </ul>	<ul style="list-style-type: none"> <li>Select correct video mode, ANALOG or HDMI.</li> </ul>	20
	<ul style="list-style-type: none"> <li>Mismatch setting between TV and this unit.</li> </ul>	<ul style="list-style-type: none"> <li>Select the correct Video Output setting.</li> </ul>	54
	<ul style="list-style-type: none"> <li>Wrong connection.</li> </ul>	<ul style="list-style-type: none"> <li>Check the connection.</li> </ul>	18-20
Dotted lines or green lines in HDMI mode.	<ul style="list-style-type: none"> <li>HDMI mode was off accidentally.</li> </ul>	<ul style="list-style-type: none"> <li>Select HDMI mode through the ANALOG/HDMI switch on the front panel.</li> </ul>	20
Only portion of the picture is displayed in HDMI mode.	<ul style="list-style-type: none"> <li>TV does not support the selected picture resolution.</li> </ul>	<ul style="list-style-type: none"> <li>Press HDMI button to select another picture resolution.</li> </ul>	20
No sound.	<ul style="list-style-type: none"> <li>The equipment connected with the audio cable is not set to receive DVD signal output.</li> </ul>	<ul style="list-style-type: none"> <li>Select the correct input mode of the audio receiver so you can listen to the sound from the DVD video player.</li> </ul>	26
	<ul style="list-style-type: none"> <li>The audio/HDMI cable is not connected securely.</li> </ul>	<ul style="list-style-type: none"> <li>Connect the audio cable securely into the appropriate jacks.</li> </ul>	18-23
	<ul style="list-style-type: none"> <li>The audio receiver or TV is turned off.</li> </ul>	<ul style="list-style-type: none"> <li>Turn on the equipment connected with the audio cable.</li> </ul>	26
	<ul style="list-style-type: none"> <li>The setting of output sound format is incorrect.</li> </ul>	<ul style="list-style-type: none"> <li>Select the proper audio setting.</li> </ul>	41,50,55
	<ul style="list-style-type: none"> <li>In HDMI mode, Digital Out is not set to PCM.</li> </ul>	<ul style="list-style-type: none"> <li>Change Digital Out to PCM.</li> </ul>	55
The playback picture has occasional distortion.	<ul style="list-style-type: none"> <li>The disc is dirty.</li> </ul>	<ul style="list-style-type: none"> <li>Eject the disc and clean it.</li> </ul>	9
	<ul style="list-style-type: none"> <li>It is in fast forward or fast reverse playback.</li> </ul>	<ul style="list-style-type: none"> <li>Sometimes a small amount of picture distortion may appear. This is not a malfunction.</li> </ul>	-
Brightness or picture is unstable or noises are present in the pictures.	<ul style="list-style-type: none"> <li>The effect of copy protection.</li> </ul>	<ul style="list-style-type: none"> <li>Connect the DVD video player directly to the TV. Avoid connecting the DVD video player to a VCR or TV/VCR combination.</li> </ul>	18
	<ul style="list-style-type: none"> <li>The effect of multi video output connections.</li> </ul>	<ul style="list-style-type: none"> <li>Connect only the cable for the output mode that you want to use.</li> </ul>	18-20
The DVD video player does not start playback.	<ul style="list-style-type: none"> <li>No disc is inserted.</li> </ul>	<ul style="list-style-type: none"> <li>Insert a disc.</li> </ul>	26
	<ul style="list-style-type: none"> <li>An unplayable disc is inserted.</li> </ul>	<ul style="list-style-type: none"> <li>Insert a playable disc. (Check the disc type and color system.)</li> </ul>	10
	<ul style="list-style-type: none"> <li>The disc is placed upside down.</li> </ul>	<ul style="list-style-type: none"> <li>Place the disc with the playback side down.</li> </ul>	26
	<ul style="list-style-type: none"> <li>The disc is not placed within the guide.</li> </ul>	<ul style="list-style-type: none"> <li>Place the disc correctly inside the guide on the disc tray.</li> </ul>	26
	<ul style="list-style-type: none"> <li>The disc is dirty.</li> </ul>	<ul style="list-style-type: none"> <li>Clean the disc.</li> </ul>	9
	<ul style="list-style-type: none"> <li>The parental lock function is set.</li> </ul>	<ul style="list-style-type: none"> <li>Cancel the parental lock function or change the parental lock level.</li> </ul>	50,55
Playback does not follow the course of the disc's program.	<ul style="list-style-type: none"> <li>It is in the mode of repeat playback, memory playback, etc.</li> </ul>	<ul style="list-style-type: none"> <li>These operations may prevent a proper progress of the contents.</li> </ul>	-
Buttons do not work.	<ul style="list-style-type: none"> <li>Power supply fluctuations or other abnormalities such as static electricity may interrupt correct operations.</li> </ul>	<ul style="list-style-type: none"> <li>Press and hold the ON/STANDBY button on the front panel for more than about 3 seconds. The DVD video player turns off. Press the button again to turn it on. If the buttons still do not work, disconnect the power plug and insert it into the wall outlet again.</li> </ul>	-
The remote control does not work properly.	<ul style="list-style-type: none"> <li>The remote control is not pointed at the remote sensor of the DVD video player.</li> </ul>	<ul style="list-style-type: none"> <li>Point the remote control at the remote sensor of the DVD video player.</li> </ul>	15
	<ul style="list-style-type: none"> <li>The remote control is too far from the DVD video player.</li> </ul>	<ul style="list-style-type: none"> <li>Operate the remote control within about 7 m.</li> </ul>	15
	<ul style="list-style-type: none"> <li>The batteries in the remote control are exhausted.</li> </ul>	<ul style="list-style-type: none"> <li>Replace the batteries with new ones.</li> </ul>	15

## DVD video player / outputs / supplied accessories

### DVD Video Player

Power supply	120 V AC, 60 Hz
Power consumption	11W
Mass	1.6 kg
External dimensions	430 x 50 x 200 mm (W/H/D)
Signal system	Standard NTSC
Laser	Semiconductor laser, wavelength 650/780 nm
Frequency range	DVD linear sound : 48 kHz sampling 4 Hz to 22 kHz 96 kHz sampling 4 Hz to 44 kHz
Signal-to-noise ratio	More than 100 dB
Audio dynamic range	More than 93 dB
Harmonic distortion	Less than 0.005 %
Wow and flutter	Below measurable level (less than $\pm 0.001$ % (W.PEAK))
Operating conditions	Temperature: 5 °C to 35 °C, Operation status: Horizontal

### Outputs

Video output	1.0 V (p-p), 75 $\Omega$ , negative sync., pin jack x 1
S Video output	(Y) 1.0 V (p-p), 75 $\Omega$ , negative sync., Mini DIN 4-pin x 1 (C) 0.286 V (p-p), 75 $\Omega$
Component video output	(Y) 1.0 V (p-p), 75 $\Omega$ , negative sync., pin jack x 1 (P <sub>B</sub> )/(P <sub>R</sub> ) 0.7 V (p-p), 75 $\Omega$ , pin jack x 2
Audio output (COAXIAL DIGITAL)	0.5 V (p-p), 75 $\Omega$ , pin jack x 1
Audio output (ANALOG)	2.0 V (rms), 680 $\Omega$ , pin jacks (L, R) x 1
Audio output (OPTICAL DIGITAL)	Optical connector x 1
HDMI output	19 pin

### Supplied Accessories

Remote control (SE-R0141) .....	1
Audio/Video cable .....	1
Batteries (AAA) .....	2
HDMI cable .....	1

- Designs and specifications are subject to change without notice.

## Limited United States Warranty DVD Players - Exchange Warranty

Toshiba America Consumer Products, L.L.C. ("TACP") makes the following limited warranties to original consumers in the United States. THESE LIMITED WARRANTIES EXTEND TO THE ORIGINAL CONSUMER PURCHASER OR ANY PERSON RECEIVING THIS DVD PLAYER AS A GIFT FROM THE ORIGINAL CONSUMER PURCHASER AND TO NO OTHER PURCHASER OR TRANSFEREE.

PRODUCTS PURCHASED IN THE U.S.A. AND USED IN CANADA ARE NOT COVERED BY THESE WARRANTIES.

PRODUCTS PURCHASED IN CANADA AND USED IN THE U.S.A. ARE NOT COVERED BY THESE WARRANTIES.

### Limited Ninety (90) Day Warranty

TACP warrant this DVD PLAYER and its parts against defects in materials or workmanship for a period of ninety (90) days after the date of original retail purchase. DURING THE FIRST 90 DAYS FROM THE PURCHASE DATE, TACP WILL EXCHANGE A DEFECTIVE DVD PLAYER WITH A NEW OR REFURBISHED PLAYER WITHOUT CHARGE TO YOU. YOU MUST CONTACT TOSHIBA'S CONSUMER SOLUTIONS CENTER FOR INSTRUCTIONS ON HOW TO PROCESS YOUR IN WARRANTY EXCHANGE REQUEST. THE CONSUMER IS RESPONSIBLE FOR ALL INBOUND TRANSPORTATION AND INSURANCE CHARGES FOR THE DVD PLAYER TO THE EXCHANGE CENTER. DURING THE PERIOD FROM 91 DAYS AND BEYOND, FROM THE PURCHASE DATE, TACP WILL EXCHANGE A DEFECTIVE DVD PLAYER WITH A NEW OR REFURBISHED PLAYER FOR A NOMINAL FEE. YOU MUST CONTACT TOSHIBA'S CONSUMER SOLUTIONS CENTER FOR INSTRUCTIONS ON HOW TO PROCESS YOUR EXCHANGE REQUEST. THE CONSUMER IS RESPONSIBLE FOR ALL INBOUND TRANSPORTATION AND INSURANCE CHARGES FOR THE DVD PLAYER TO THE EXCHANGE CENTER.

### \*Rental Units

The warranty for rental units begins with the first rental or thirty (30) days from the date of shipment to the rental firm, whichever comes first.

### \*Commercial Units

DVD PLAYERS sold and used for commercial purposes have a limited ninety (90) day warranty for all parts, labor.

### Owner's Manual and Demographic Card

You should read this owner's manual thoroughly before operating this DVD PLAYER. You should complete and mail the enclosed Demographic card within ten days after you, or the person who has given you this product as a gift, purchased this DVD PLAYER. This is one way to enable TACP to provide you with better customer service and improved products. Failure to return the Demographic card will not affect your rights under this warranty.

### Your Responsibility

THE ABOVE WARRANTIES ARE SUBJECT TO THE FOLLOWING CONDITIONS:

- (1) You must provide your bill of sale or other proof of purchase.
- (2) All warranty servicing of this DVD PLAYER must be made by an Authorized TACP Service Station.
- (3) The warranties from TACP are effective only if the DVD PLAYER is purchased and operated in the U.S.A. or Puerto Rico.
- (4) Labor service charges for set installation, set up, adjustment of customer controls and installation or repair of antenna systems are not covered by these limited warranties. Reception problems caused by inadequate antenna system are your responsible.
- (5) Warranties extend only to defects in materials or workmanship as limited above and do not extend to any DVD PLAYER or parts which have been lost or discarded by you or to damage to DVD PLAYER or parts caused by misuse, accident, Acts of God, such as lightning or fluctuations in electric power, improper installation, improper maintenance or use in violation of instructions furnished by TACP; or to units which have been modified or had the serial number removed, altered, defaced or rendered illegible.

### How to Obtain Warranty Services

If, after following all of the operating instructions in this manual and checking the section "Before Calling Service Personnel", you find that service is needed:

- (1) For instructions on how to obtain warranty service for exchange program DVD Players contact TACP's toll free Call Center at **1-866-583-7353**.
- (2) Include your bill of sale or other proof of purchase along with the DVD player, when sending it to the Authorized TACP Service Station SPECIFIED by TACP's Call Center. You must pay for all transportation and insurance charges for the DVD Product to and from the Service Station.

For additional information, visit TACP's web site:

[www.tacp.toshiba.com](http://www.tacp.toshiba.com)

ALL WARRANTIES IMPLIED BY THE LAW OF ANY STATE OF THE U.S.A., INCLUDING THE IMPLIED WARRANTIES OF MERCHANTABILITY AND FITNESS FOR A PARTICULAR PURPOSE, ARE EXPRESSLY LIMITED TO THE DURATION OF THE LIMITED WARRANTIES SET FORTH ABOVE. WITH THE EXCEPTION OF ANY WARRANTIES IMPLIED BY THE LAW OF ANY STATE OF THE U.S.A. AS HEREBY LIMITED, THE FOREGOING WARRANTY IS EXCLUSIVE AND IN LIEU OF ALL OTHER WARRANTIES, GUARANTEES, AGREEMENTS AND SIMILAR OBLIGATIONS OF TACP WITH RESPECT TO THE REPAIR OR REPLACEMENT OF ANY PARTS. IN NO EVENT SHALL TACP BE LIABLE FOR CONSEQUENTIAL OR INCIDENTAL DAMAGES.

No person, agent, distributor, dealer or company is authorized to change, modify or extend the terms of these limited warranties in any manner whatsoever. The time within which action must be commenced to enforce any obligation of TACP arising under this warranty or under any law of the United States or of any state thereof is hereby limited to 90 days from the date you discovered or should have discovered, the defect. This limitation does not apply to implied warranties arising under the law of any state of the U.S.A.

THIS WARRANTY GIVES YOU SPECIFIC LEGAL RIGHTS, AND YOU MAY ALSO HAVE OTHER RIGHTS WHICH MAY VARY FROM STATE TO STATE IN THE U.S.A. SOME STATES OF THE U.S.A. DO NOT ALLOW LIMITATIONS ON HOW LONG AN IMPLIED WARRANTY LASTS, WHEN AN ACTION MAY BE BROUGHT, OR THE EXCLUSION OR LIMITATION OF INCIDENTAL OR CONSEQUENTIAL DAMAGES, SO THE AFOREMENTIONED LIMITATIONS OR EXCLUSIONS MAY NOT APPLY TO YOU UNDER SUCH CIRCUMSTANCES.

**TOSHIBA**

**- IMPORTANT -  
CANADIAN WARRANTY INFORMATION  
GARANTIE CANADIENNE**

STANDARD WARRANTY  
TYPE OF SET

DVD Player  
DVD/VCR Combination  
Home Theatre in a Box  
DVD Recorder  
Portable DVD

GARANTIE NORMALE  
TYPE D'APPAREIL

Lecteur DVD  
DVD/magnétoscope combo  
Cinéma maison dans une boîte  
Enregistreur DVD  
DVD Portatif

WARRANTY PERIOD

12 MONTHS

DURÉE DE LA GARANTIE: 12 MOIS

**CANADIAN WARRANTY**

Toshiba of Canada Limited (TCL) makes the following limited warranties to original consumers in Canada. Please retain your "Bill of Sale" as proof of purchase. **To obtain a "Canadian Warranty" please register online at [www.toshiba.ca](http://www.toshiba.ca).**

**Canadian Warranty Information**

Should service be required on this unit during the one year warranty period, TCL's option will be to repair or exchange the defective unit. It will be necessary to follow this procedure:

**Contact:** Toshiba of Canada Limited at the Consumer Electronics Group, customer support line.

**Phone:** 1-800-268-3404

**Email:** [ceg\\_customer\\_support@toshiba.ca](mailto:ceg_customer_support@toshiba.ca)

All in-warranty repairs must be made by an authorized TCL service centre.

For service exchange TCL will arrange to have the unit picked up by courier and a replacement unit will be returned via same courier. (Note: A major credit card number will be required as a charge of \$25.00 will apply if no fault is found with the unit.) During the first 3 months of ownership, a new unit will be supplied as a replacement. During the remainder of the warranty period a service-renewed unit will be supplied. The original "Bill of Sale" must be provided as proof of purchase (it will be returned with the replacement unit.)

**This 12-month warranty will be strictly adhered to.**

Out of warranty units should be repaired by a TCL authorized service centre.

Note: It is the responsibility of the owner to ensure proper packaging. Should damage in shipping occur, due to poor packaging, a charge back for the repair will result. This warranty applies to the original purchaser only and is not transferable.

This warranty does not apply to sets that have been subjected to misuse, neglect, accident, physical damage or acts of nature.

Sets with the serial number removed, altered, replaced or defaced will not be covered by this warranty.

The warranties from TCL are effective only if the product is purchased in Canada from an authorized TCL dealer and operated in Canada.

Products utilized for rental or commercial purposes are not covered by this warranty.

This warranty is in lieu of all other warranties, guarantees or agreements, whether expressed or implied, and no person, agent distributor, dealer, service centre or company is authorized to change, modify or extend its terms in any manner whatsoever.

**GARANTIE CANADIENNE**

1) Toshiba du Canada Limit e (TLC) of fre au Canada les garanties limit es suivantes aux consommateurs origin-aux. Veuillez conserver votre < facture > comme preuve d'achat. **Pour obtenir une garantie canadienne, veuillez vous inscrire en ligne à [www.toshiba.ca](http://www.toshiba.ca).**

**Information sur la garantie Canadienne**

Si vous avez besoin de service sur cet appareil au cours le l'année de garantie, Toshiba du Canada Limitée aura l'op tion de réparer ou échanger l'appareil d féctueux. Vous devrez suivre la procédure suivante:

**Contact:** Toshiba du Canada Limitée au Groupe Électronique aux consommateurs, service à la clientèle.

**Tél:** 1-800-268-3404

**Courriel:** [ceg\\_customer\\_support@toshiba.ca](mailto:ceg_customer_support@toshiba.ca)

Toutes les réparations au cours de la garantie doivent être faites par un centre de service autorisé Toshiba.

Pour un échange TCL s'assurera qu'un service de courrier ramassera l'unité et qu'un appareil de remplacement soit expédié par le même service de courrier

(Note: Un numéro de carte de crédit sera requis car une charge de 25,00\$ sera appliquée si toutefois l'appareil n'avait aucun problème de fonctionnement.)

Une nouvelle unité sera fournie comme remplacement durant les premiers 3 mois de propriété. Par contre durant la balance de la garantie une unité remise à neuf sera fournie.

La <facture> originale doit être fournie comme preuve d'achat (elle vous sera retournée avec l'unit de remplacement.)

**Cette garantie de 12 mois sera strictement adhéree.**

Les unités hors de garantie devraient être réparées par un centre de service autorisé Toshiba.

Note: C'est la responsabilité du propriétaire de s'assurer que l'emballage est adéquat. Vous serez facturé pour toutes réparations causées par des dommages encourus à cause d'un emballage non adéquat.

Cette garantie est octroyée à l'acheteur initial et n'est pas transférable. Cette garantie ne s'applique pas aux appareils qui ont été sujets aux abus, négligences, accidents, dommages physiques ou actes naturels.

Les appareils dont le numéro de série a été enlevé, altéré, remplacé ou barbouillé ne sont pas couverts par cette garantie.

Les garanties de TCL sont valides seulement sur les unités sont achetées et utilisées au Canada d'un marchand autorisé TCL.

Cette garantie ne couvre pas les produits de location ou à usage commercial. Cette garantie remplace toutes autres garanties ou ententes exprimées ou sous-entendues. Aucune personne, agent, distributeur, concessionnaire ou compagnie n'est autorisé à changer, modifier ou prolonger les termes de cette garantie de quelque façon que ce soit.





**TOSHIBA**

Printed in China  
811-597091-010